

[Home](#) .| [The Newsroom](#) .| [Copyrights](#) .| [Trademarks](#) .| [Documents](#) .| [Veritas](#) .| [Remote Viewing](#) .| [Complaint Dept.](#)

### THANK YOU FOR CONTRIBUTIONS

Thanks to everyone who has written in with additional information for the timeline. The response has been overwhelming (with creaking bandwidth, too). Although we can't respond to individual email, it's all being read, and all verifiable relevant entries are being added as fast as possible. Some have been very revealing. All are greatly appreciated. [Click here to send additions.](#)

The page below was sent to us and it began to answer many of the previously unanswered questions that had been raised by the information on this site. We're presenting it the way we received it. We've now deleted the red box on censorship that came with it. Based on the response, the censorship by Wikipedia and Ed Dames are meaningless. We are proud to have the opportunity to present this extraordinary document:

## Remote Viewing Timeline

This timeline details United States government development of parapsychology for military intelligence purposes, leading to a secret CIA-initiated program that became commonly known as "remote viewing." The timeline reaches to the beginnings of Central Intelligence Agency (CIA) mind research and experimentation in the late 1940s, and includes parallel information on similar research being carried out simultaneously in the Soviet Union during the Cold War.

Because of a secret contract between the CIA and highly trained Scientologists at the inception of the CIA-initiated remote viewing program, events related to Scientology and L. Ron Hubbard that led up to the unlikely marriage of CIA and Scientology are included.

Also included are key events involving CIA and other U.S. intelligence agencies that are parallel to the evolution of remote viewing, and that are linked to its development in ways that are as inexplicable as they are inextricable. As a result, the remote viewing timeline necessarily is a partial timeline of events and people related to the Pentagon Papers and Watergate.

### Contents

- [1940s](#)
- [1950s](#)
- [1960s](#)
- [1970](#)
- [1971](#)
- [1972](#)
- [1973](#)
- [1974](#)
- [1975](#)
- [1976](#)
- [1977](#)
- [1978](#)
- [1979](#)
- [1980s to Present](#)
- [Afterword](#)
- [References](#)

## 1940s

**October 1943**

- E. Howard Hunt is confirmed for service in Office of Strategic Services (OSS), forerunner to CIA. Hunt goes to Catalina Island for training. Among the people Hunt trains with is Lucien Conein.<sup>[1]</sup>



CIA's E. Howard Hunt

**1946**

- Psychiatrist Lewis J. Fielding joins the Veteran's Administration (VA) in Los Angeles as staff psychiatrist and instructor in clinical psychiatry. When Fielding joins the VA, and intermittantly over the next several years, Dianetics and Scientology founder L. Ron Hubbard is living in and around L.A., doing Dianetic research. He has opened an office in Hollywood, California, and is delivering Dianetic processing to people. When there, he is associated with the Los Angeles Veteran's Administration. *[NOTE: Fielding later will be integral to incidents involving CIA's E. Howard Hunt, Daniel Ellsberg, Lucien Conein, the Pentagon Papers, and the Watergate scandal—at the very time that CIA is secretly setting up its remote viewing program using highly trained Scientologists. See timeline years 1971 and 1972.]*<sup>[2][3][4]</sup>

**Thursday, 18 September 1947**

- The National Security Act of 1947 establishes the Central Intelligence Agency (CIA). Robert Komer is in the CIA at its inception. *[NOTE: Komer will become a close associate of Daniel Ellsberg at Rand and will be with Ellsberg in Vietnam.]*<sup>[5][6]</sup>

**Wednesday, 15 October 1947**

- A letter purportedly from L. Ron Hubbard, dated 15 October 1947, ends up in his Veteran's Administration files in Los Angeles, where Lewis J. Fielding is staff psychiatrist. The subject of the letter is Hubbard pleading with the VA for psychiatric help. *[NOTE: The letter never surfaces until decades later, and then only as a copy several generations removed, making its authenticity impossible to prove or disprove.]*<sup>[7]</sup>

**June 1948**

- With CIA liaison for administration and supply, a separate clandestine organization called Office of Policy Coordination (OPC) is created. On CIA orders, E. Howard Hunt reports to Washington, D.C. to begin service in OPC.<sup>[1]</sup>

**July 1949**

- CIA's head of Scientific Intelligence goes to Western Europe to learn Soviet techniques in mind control and interrogation, including use of LSD.<sup>[8]</sup>

**1950s****Thursday, 20 April 1950**

- CIA's mind control program Project BLUEBIRD is authorized. CIA-contracted psychiatrists begin secret experiments with ice-pick lobotomies, electroshock, hypnosis, pain, and drugs, including cocaine, heroin, and LSD. In coordination with the Veteran's Administration, U.S. military veterans are used as unwitting subjects for many of the experiments.<sup>[9][8]</sup>

**Tuesday, 9 May 1950**

- The book *Dianetics, the Modern Science of Mental Health* by L. Ron Hubbard is released. It decries hypnosis, and describes techniques for safely accessing in the mind the contents of incidents involving unconsciousness, hypnosis, drugs, and pain. It becomes a bestseller.<sup>[10][11]</sup>

**Saturday, 27 May 1950**

- The Office of Naval Intelligence in Washington, D.C. sends an officer to put L. Ron Hubbard into civilian service in the government to continue his researches on the mind. Hubbard says no. The officer says that if he refuses, Hubbard will be ordered back to active duty, since his Naval commission has not been terminated. Hubbard quickly takes advantage of a letter of permission he has from the Secretary of the Navy to resign his commission, thereby putting Dianetics and Scientology out of the reach and control of the U.S. government.<sup>[12][13]</sup>



With *Dianetics* a bestseller, L. Ron Hubbard (right) is lecturing around the country when U.S. Naval Intelligence attempts to force him into service for the U.S. government. He refuses.

**September 1950**

- As CIA's Project BLUEBIRD expands, the CIA-contracted psychiatrists' experimental purposes and activities include inducing amnesia, inserting hypnotic access codes in subjects' minds, controlling behavior from remote transmitters with brain electrodes, administering LSD to children, and using electroshock to erase memories.<sup>[9]</sup>

**1951**

- Office of Policy Coordination (OPC), where E. Howard Hunt is working, is merged with CIA. Over the coming years, during his CIA career, Hunt has other occasions to work with Lucien Conein, who is on contract to CIA.<sup>[1]</sup>

**January 1951**

- L. Ron Hubbard introduces the "Theta-MEST Theory" stating that thought (Theta) is separate from the physical universe (Matter, Energy, Space and Time—MEST): that Theta can operate in and with MEST, that Theta can consider itself integrated with MEST, and that Theta can consider itself to be MEST, but that creative thought and perception reside in Theta, not MEST.<sup>[14]</sup>

**Monday, 25 June 1951**

- L. Ron Hubbard exposes "a carefully guarded secret of certain military and intelligence organizations." In a new book, *Science of Survival*, Hubbard says: "It required Dianetic processing to uncover pain-drug-hypnosis. Otherwise, pain-drug-hypnosis was out of sight, unsuspected, and unknown." Hubbard denounces its use as a "vicious war weapon" that may be "of considerably more use in conquering a society than the atom bomb." [NOTE: It's not until decades later that CIA's pain-drug-hypnosis experimentation during this period begins to be investigated and reported by Congress. By that time, CIA's Richard Helms, Sidney Gottlieb, and others will have destroyed many of CIA's records of such activities. See January 1973.]<sup>[15]</sup>

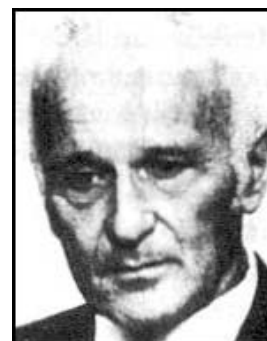

CIA's Sidney Gottlieb

**Monday, 20 August 1951**

- CIA's Project BLUEBIRD evolves into Project ARTICHOKE, with goals such as "get control of an individual to the point where he will do our bidding against his will and even against fundamental laws of nature."<sup>[16]</sup>

**Monday, 7 January 1952**

- A secret internal CIA document discusses a multi-level program to research and develop the use of extrasensory perception for "practical problems of intelligence."<sup>[17]</sup>

**July 1952**

- L. Ron Hubbard releases a book, *History of Man* (published also as *What to Audit*), that describes some of the native capabilities of thought (Theta) in the individual as including communication by telepathy and the moving of material objects by "throwing an energy flow at them." Hubbard describes Scientology processes to rehabilitate these potentials.<sup>[18]</sup>

### Wednesday, 6 August 1952

- Alexander Puharich delivers a lecture called "On the Possible Usefulness of Extrasensory Perception in Psychological Warfare" to a Pentagon conference.<sup>[19]</sup>

*On the Possible Usefulness  
of Extrasensory Perception in Psychological Warfare"  
becomes a decades-long intelligence agenda  
for the Cold War.*

### December 1952

- George Hunter White, on loan to CIA from the Federal Narcotics Bureau, begins administering LSD to unwitting U.S. citizens at a CIA "safehouse" in Greenwich Village.<sup>[20]</sup>
- L. Ron Hubbard delivers a series of over 50 lectures in Philadelphia on processes for attaining a state he calls "Operating Thetan" (OT), described as a being stably exterior from the body and able to perceive, communicate, and operate in the physical universe without reliance on the sense channels or mechanics of a body.<sup>[21]</sup>

### 1953

- James McCord, later to be involved in the Watergate break-in, joins CIA.<sup>[22]</sup>

### Friday, 10 April 1953

- CIA director Allen Dulles gives a speech before the National Alumni Conference at Princeton University, lecturing on "how sinister the battle for men's minds" has become in Soviet hands.<sup>[23]</sup>

### Monday, 13 April 1953

- CIA Director Allen Dulles authorizes a new expanded mind-control program, MK-ULTRA, brainchild of Richard Helms, a high-ranking member of CIA's Clandestine Services. E. Howard Hunt is working at CIA headquarters at the time as a "chief of covert operations" under Clandestine Services.<sup>[23][24][1]</sup>



CIA's Richard Helms

### Thursday, 19 November 1953

- On a 3-day holiday for CIA officials at Deer Creek Lodge in the mountains of Maryland, Sidney Gottlieb—head of CIA's MK-ULTRA—secretly slips LSD into the after-dinner drinks. An Army scientist and germ warfare specialist named Frank Olson, who is working on an MK-ULTRA project, experiences a "bad trip," becoming very disoriented. [NOTE: Olson soon commits suicide.]<sup>[20]</sup>

### Circa July 1955

- George Hunter White moves his CIA "safe house" operation, equipped with one-way mirrors and surveillance gadgets, to San Francisco, under the aegis of MK-ULTRA and Sidney Gottlieb. The code name is *Operation Midnight Climax*. He hires prostitute addicts who lure men from bars to the safe houses after their drinks have been spiked with LSD. White films the events. The purpose of these "national security brothels" is to enable CIA to experiment with the act of lovemaking for extracting information from men.<sup>[25]</sup>

- Factions of the U.S. government are making efforts to "seize Scientology in the United States."<sup>[26]</sup>

### Monday, 15 August 1955

- Staff of CIA Director Allen Dulles complete "A Report on Communist Brainwashing."<sup>[27]</sup>

### Wednesday, 2 January 1957

- The Church of Scientology of California, the senior church, is granted tax exemption.<sup>[28]</sup>

### July 1957

- The CIA has file No. 156409 on L. Ron Hubbard and his organizations.<sup>[29]</sup>

### January 1958

- L. Ron Hubbard introduces the "American Blue E-meter," a transistorized improvement over earlier prototypes, to be used as an aid for Scientology practitioners. Newer Scientology technology begin to require the use of the meter as a guide to the use of processes toward the attainment of Operating Thetan (OT).<sup>[11]</sup>

### June 1958

- Daniel Ellsberg arrives at Rand to spend the summer as a consultant.<sup>[30]</sup>

### Circa July 1958

- U.S. corporations, including Westinghouse, General Electric, and Bell Telephone have begun telepathy research.<sup>[17]</sup>

### Saturday, 8 November 1958

- The *Herald Tribune* in New York reports that Westinghouse Electric Corporation has begun to study ESP using specially designed apparatus.<sup>[17]</sup>

### Saturday, 25 July 1959

- Westinghouse Corporation's Friendship Laboratory undertakes an experiment in ESP with the *U.S.S. Nautilus*, linking one person on land (the sender) with another person in the submarine (the receiver), while the vessel is submerged. Representatives of the U.S. Navy and Air Force are present during the experiments, which run for sixteen days under Air Force Colonel William H. Bowers. The experiments result in a 70% success rate.<sup>[17]</sup>



L. Ron Hubbard discovers measurable sentience in plants, first using an E-meter with geraniums in his greenhouse at St. Hill, England, later with tomatoes

### Friday, 18 December 1959

- *Garden News* publishes a story, "Plants Do Worry and Feel Pain," describing experiments done by L. Ron Hubbard where he has connected plants to a Scientology E-meter and measured their reaction to threat and damage.<sup>[31]</sup>

## 1960s

### Monday, 17 April 1961

- Martin Ebon, administrative assistant of the Parapsychology Association in New York and on staff with the U.S. Information Agency, is in Washington, D.C. giving a briefing on telepathy to "a top intelligence agency." He is a specialist in tracking and examining the nature and direction of Russian and Soviet security services.<sup>[17]</sup>

**Tuesday, 25 July 1961**

- L. Ron Hubbard goes from St. Hill in England to Cape Finisterre, Spain for about 10 days and purchases a ship that is 106 feet long with an 18 foot beam and sleeps about 22 people. He says that purchase of the ship is "part of an operation" he is conducting from St. Hill. *[NOTE: This event is the earliest indication of Hubbard's creation, in Spain, of the confidential Sea Project, later to be called the Sea Org, which he establishes to protect and deliver the confidential upper levels of Scientology. This is the first ship purchased. The Sea Project will not be made known publically for several years. Later, Hubbard writes that the oldest yacht in the Sea Org is the Enchanter.]*<sup>[32][33]</sup>

**Tuesday, 1 August 1961**

- The Defense Intelligence Agency (DIA) is created in the Department of Defense (DOD) by DOD Directive 5105.21, August 1, 1961. *[NOTE: After the 1971-1972 creation of the CIA-initiated remote viewing program, its administration later gets transferred, at least in part, to DIA as one action of the remote viewing shell-game of secrecy that goes on for decades.]*

*The Soviet Union claims to have confirmed communication between two people separated by long distances...without conventional communication facilities."*

**July 1962**

- A book published in the Soviet Union, "Biological Radio Communication," claims "experimental confirmation of the fact that communication between two people separated by long distances can be carried out through water, over air and across metal barrier by means of cerebral radiation in the course of thinking, and without conventional communication facilities."<sup>[17]</sup>

**1963**

- CIA organizes the Robert R. Mullen public relations firm as a CIA front company for use "mainly in providing CIA cover overseas." Mullen has several overseas branches for its ciafront operations and an office in Washington, D.C.. One of its branches in Europe is staffed, run, and paid for by CIA. *[NOTE: E. Howard Hunt will retire from CIA and go to work for Mullen on 1 May 1970 (see). At the time of his purported retirement, Hunt will be CIA's Chief EUR/CA]*<sup>[34]</sup>
- CIA's Richard Helms attempts to defend CIA drug operations like *Midnight Climax* by telling CIA Inspector General John Earman that such testing has been necessary "to keep up with the Soviets."<sup>[25]</sup>

**Friday, 4 January 1963**

- Deputy Marshals and Food and Drug Administration Agents raid the Scientology headquarters in Washington, D.C. and seize 100 E-meters along with Scientology publications on the grounds that the E-meters are "misbranded."<sup>[35]</sup>



Feds seize Scientology E-meters

**1964**

- Daniel Ellsberg is granted a unique security clearance giving him "unprecedented access to data and studies in all agencies," as well as several "special clearances" including "very high-level access to all our secrets in the State and Defense Departments and the CIA."<sup>[2]</sup>

### Circa November 1964

- Richard Helms, Director of CIA and father of MK-ULTRA, contradicts himself on the need "to keep up with the Soviets," telling the Warren Commission that "Soviet research has consistently lagged five years behind Western research."<sup>[25]</sup>

### Early January 1965

- L. Ron Hubbard and Mary Sue Hubbard leave St. Hill in England and travel to Spain, going first at the Canary Islands—a province of Spain—off the coast of Morocco. His research into upper levels of Scientology is now confidential, and while in Spain and the Canary Islands, he lays the groundwork for establishing confidential bases in Spain to deliver the upper levels. They return to St. Hill mid-February 1965.<sup>[31][36]</sup>

### Monday, 17 May 1965

- Psychiatrist Jose Delgado gives a mind control demonstration in Spain with a bull: he presses a button on a radio transmitter and the bull brakes to a halt. He presses another button and the bull turns to the right and trots away, obeying commands being delivered through radio signals to brain regions in which fine wires had been planted the day before.<sup>[25]</sup>



CIA Director Helms testifies. He later will be convicted of perjury for lying to Congress.

### Monday, 14 June 1965

- L. Ron Hubbard issues "Politics, Freedom From" in Executive Directive form, declaring Scientology to be "nonpolitical and nonideological," and declaring it "free of any political connection or allegiance of any kind whatever." He says the reason for the declaration is the continuing efforts of the U.S. government "to seize Scientology in the United States." In closing he says: "Scientologists may be members of any political group on this planet without restraint only so long as these individuals or that group do not attempt to seize Scientology for their own warlike ends and so make it unworkable or distasteful by invidious connection."<sup>[26]</sup>

### Tuesday, 29 June 1965

- L. Ron Hubbard tells a group of Scientology students in a lecture at St. Hill in England that he has recently returned from Washington D.C. where IRS and factions of the U.S. government have been "trying to seize Scientology in the United States," and that he has told them an emphatic "no."<sup>[37]</sup>

### July 1965

- E. Howard Hunt converts from "CIA employee" to "CIA contract status" and is sent by Richard Helms on a secret mission to Madrid, Spain. The Canary Islands, where L. Ron Hubbard has recently begun to establish a base for upper level Scientology research, is a province of Spain at the time.<sup>[38][1]</sup>
- In a meeting with CIA's William Colby it is arranged that Daniel Ellsberg will be traveling to Vietnam with E. Howard Hunt's long-time associate, CIA's Lucien Conein, on a team headed up by 20-year CIA veteran Edward Lansdale [often misspelled as Edward Landsdale].<sup>[30]</sup>



Hunt and Hubbard in Spain

### Friday, 3 September 1965

- L. Ron Hubbard inaugurates the confidential Clearing Course, available only at St. Hill in East Grinstead, Sussex, England.<sup>[3]</sup>

**Monday, 11 October 1965**

- Moscow's A.S. Popov Scientific-Technical Society for Radio Engineering, Electronics and Communication establishes a Laboratory for Bio-Information to conduct laboratory-controlled telepathic experiments. [NOTE: Also referred to as Soviet Laboratory for Bio-Electronics and the Laboratory for Bio-Communications.]<sup>[17]</sup>

**Sunday, 17 October 1965**

- Daniel Ellsberg has arrived in Vietnam with CIA's Edward Lansdale [often misspelled as Edward Landsdale] and Lucien Conein, and is put in touch with John Paul Vann. Through Vann, Ellsberg meets reporter Neil Sheehan. For about six weeks Vann drives Ellsberg around to every province capital in "III Corps"—the eleven provinces that include Saigon. [NOTE: Neil Sheehan will later publish secret documents given to him by Ellsberg: the *Pentagon Papers*.]<sup>[30]</sup>

**Tuesday, 14 December 1965**

- Stephen I. Abrams, Director of the Parapsychological Laboratory, Oxford University in England, working under the auspices of CIA's MK-ULTRA, prepares a review article entitled "Extrasensory Perception." It says ESP has been demonstrated, but is not understood or controllable.<sup>[19]</sup>

*L. Ron Hubbard forbids access to  
confidential Scientology upper levels for anyone connected  
to police spy organizations and government spy  
organizations including CIA, IRS, FBI, and NSA.*

**Tuesday, 28 December 1965**

- L. Ron Hubbard issues a Scientology policy letter that forbids anyone connected to a "Suppressive Group" from being allowed onto the confidential Scientology upper levels unless and until the group is permanently disbanded. "Suppressive Groups" are defined as those that "seek to destroy Scientology" or specialize in "injuring or killing people or damaging their cases," or that "advocate the suppression of Mankind." They include "police spy organizations and government spy organizations" such as the CIA, IRS, FBI, National Security Agency (NSA), Department of Justice (DOJ), "or any other federal agency in any country."<sup>[39][40]</sup>

**Wednesday, 2 February 1966**

- CIA contractor Cleve Backster connects plants to polygraphs and gets reactions on the machines when the plants are threatened or harmed. [NOTE: These are almost identical to plant experiments done by L. Ron Hubbard over six years earlier using the Scientology E-meter. See 18 December 1959.]<sup>[41]</sup>

**March 1966**

- Daniel Ellsberg is working in Vietnam in conjunction with CIA's Intelligence Coordination and Exploitation (ICEX) operations—forerunner of the *Phoenix Project*—on "hamlet pacification," a euphemism for, among other things, kidnapping, brutal interrogations, and assassinations.<sup>[2][30]</sup>

**Thursday, 7 April 1966**

- Daniel Ellsberg is in a meeting in Vietnam with his "old friend from Rand," CIA veteran and National Security Council (NSC) member Robert Komer. At the time, Ellsberg is involved with Lucien Conein and John Paul Vann. One of the Green Berets in the various CIA "pacification programs" is Paul Preston. [NOTE: Preston later will enroll in Scientology, and will be described by some sources as

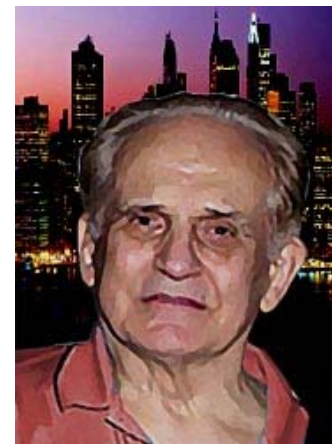

CIA's Cleve Backster plagiarizes plant response testing, giving CIA their own data set for experiments done years earlier by Hubbard that he would never share with an intelligence agency



*having become the bodyguard'of L. Ron Hubbard when Hubbard disappears. See 28 May 1972.]* <sup>[2][30]</sup>

### **Circa July 1966**

- "Special Department No. 8" is established at the Institute of Automation and Electrometry in Academgorodok, ("Science City"), near Novosibirsk, Siberia. The building that houses the department can only be entered if one knows the code, changed each week, that opens the main door's lock. The "No. 8" operation is devoted to experiments in information transmission by "bioenergetic" means. About 60 researchers have been brought to the facility from other parts of the USSR.<sup>[17]</sup>

### **Saturday, 9 July 1966**

- The Moscow daily *Komsomolskaya Pravda* reports on long-distance telepathy experiments conducted by the Moscow Laboratory of Bio-Information, using Yuri Kamensky and Karl Nikolayev. The experiments are reported to have "demonstrated the reality of the phenomenon and produced valuable data, both positive and negative, which pointed up the need for continued research."<sup>[17]</sup>

*The Soviet Union reports more  
successful telepathy experiments, escalating the Cold War  
race for supremacy in psychological warfare.*

### **Friday, 29 July 1966**

- IRS sends a letter to the senior Scientology organization, Church of Scientology of California, recommending revocation of tax exemption.<sup>[28]</sup>

### **Sunday, 14 August 1966**

- The confidential materials for the first Operating Thetan level, OT I, are released by L. Ron Hubbard to qualified Scientologists on 14 August 1966. The level is called OT I.<sup>[11]</sup>

### **Tuesday, 16 August 1966**

- L. Ron Hubbard issues a Scientology policy letter called "Clearing Course Security" with instructions on how to handle reports of anyone being a "potential security risk" with confidential upper level materials.<sup>[42]</sup>

### **Thursday, 1 September 1966**

- L. Ron Hubbard resigns from all directorships and running of Scientology organizations. At about the same time he releases to qualified Scientologists the confidential materials of "Operating Thetan Level II" (OT II).<sup>[11]</sup>

### **Wednesday, 21 September 1966**

- CIA's E. Howard Hunt returns to the Washington, D.C. area from a highly secret assignment he has been on in Spain for a little over a year. Hunt supposedly has been on a "contract" basis with CIA rather than an employee of CIA since leaving for Spain, but a CIA document of 21 September, sent to CIA's Central Cover Staff through the Office of Security refers to Hunt as "this employee." [NOTE: Also see 1970, where Hunt purportedly retires'from CIA as an employee.]<sup>[1][38]</sup>

### **Wednesday, 5 October 1966**

- Just after E. Howard Hunt arrives in D.C., Daniel Ellsberg leaves Vietnam and flies to Washington, D.C., then turns around almost immediately and makes a one week trip back to Vietnam, flying non-stop on the plane of Secretary of Defense Robert McNamara. Ellsberg is in contact again with CIA's Robert Komer.<sup>[30]</sup>

### **Wednesday, 12 October 1966**

- Daniel Ellsberg flies back from Vietnam to Washington, D.C. non-stop on McNamara's plane. With them is CIA's Robert Komer.<sup>[30]</sup>

**Thursday, 10 November 1966**

- L. Ron Hubbard has created the "Sea Project" and confidential programs for Scientology Clears and OTs to carry out.<sup>[43]</sup>

**Tuesday, 29 November 1966**

- L. Ron Hubbard gives a lecture to the Saint Hill Special Briefing Course: "OT and Clear defined," date code 6611C29, lecture code SHspec-82.

**1967**

- Ingo Swann begins to take Scientology services. At about the same time, Swann tenders his two-year notice for resignation from his permanent contract with the United Nations Secretariat in New York.<sup>[44]</sup>
- NSA's Hal Puthoff enrolls in Scientology services. *[NOTE: Puthoff will somehow get past or around the Hubbard injunction against members of a Suppressive Group being allowed access to the upper levels of Scientology, and by 1971 Puthoff will have attained the highest level, OT VII. See January 1971.]*



Harold "Hal" Puthoff from NSA and Ingo Swann from the UN enroll in Scientology, supposedly unknown to each other. Within five years they will be at the highest levels of Scientology and under secret contract with CIA to develop remote viewing for military intelligence.

**July 1967**

- IRS revokes the tax exemption of the senior Scientology organization, Church of Scientology of California (CSC), which it has had since 2 January 1957 (see).<sup>[28]</sup>

**Wednesday, 10 January 1968**

- L. Ron Hubbard reissues "Politics, Freedom From" *[see 14 June 1965]*, this time as a broad public issue Hubbard Communication Office Policy Letter, declaring Scientology to be "nonpolitical and nonideological," and declaring it "free of any political connection or allegiance of any kind whatever." He says the reason for the declaration is the continuing efforts of the U.S. government "to seize Scientology in the United States."<sup>[26]</sup>



L. Ron Hubbard issues "Politics, Freedom From" as policy

**February 1968**

- "American intelligence analysts" begin "noticing a Soviet secret police (KGB) trend...indicating serious interest in what is called 'parapsychology' in the West."<sup>[17]</sup>
- The first Scientology "Advanced Org" is started on the Scientology Flagship (then called the *Royal Scotman*, later the *Apollo*) for the delivery of the confidential upper levels. The location is highly confidential.<sup>[45]</sup>

**March 1968**

- Daniel Ellsberg is working at Rand Corporation in Santa Monica, California. He begins having regular meetings with Beverly Hills psychiatrist Lewis J. Fielding—former staff psychiatrist of the Veteran's Administration when L. Ron Hubbard was connected with the VA there. Ellsberg purportedly is a Fielding patient.<sup>[2]</sup>

**Tuesday, 4 March 1969**

- On a trip to the Rand office in D.C. Daniel Ellsberg is given a copy of the top-secret study that will

become known as "the Pentagon Papers" for him to carry with him to the Rand office in Santa Monica, California where he works.<sup>[30]</sup>

#### April 1969

- Ingo Swann employment on a "permanent contract" with the United Nations Secretariat in New York comes to an end.<sup>[44]</sup>

#### Tuesday, 30 September 1969

- Daniel Ellsberg "decides to release the Pentagon Papers," purportedly because he reads in the newspaper that all charges have been dropped against several Green Berets who had been charged with a murder in Vietnam. *[NOTE: The kind of ops the Green Berets had been charged with were what Ellsberg himself had been immersed in while in Vietnam, including time spent with his good friend Robert Komer—who headed CIA's Phoenix Project of kidnappings and assassinations.]*<sup>[30]</sup>

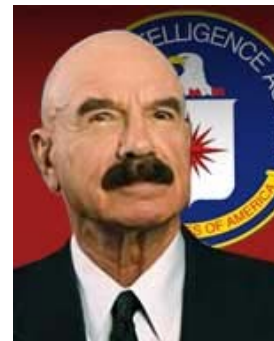

G. Gordon Liddy gets "special clearances" from CIA

#### Tuesday, 16 December 1969

- A Scientology Guardian Order says that double agents are being infiltrated into Scientology staffs and urges the use of any means to detect such infiltration.<sup>[46]</sup>

#### December 1969

- G. Gordon Liddy is granted "special clearances" by CIA.<sup>[34]</sup>

## 1970

#### January 1970

- Meade Emory is Legislation Attorney for the Joint Committee on Taxation of the U.S. Congress. *[NOTE: Emory has ties to the law firm Gall, Lane, Powell and Kilcullen in D.C. Emory will later be Assistant to Commissioner of IRS, then secretly will be the architect of several wills attributed to L. Ron Hubbard, and of the restructuring of all Scientology corporations, turning control of all Scientology materials over to non-Scientology tax attorneys appointed for life. See Meade Emory, Founder.]*<sup>[47]</sup>



IRS's Meade Emory

#### Sunday, 22 February 1970

- Yvonne Gillham, one of the earliest Sea Org members, has been Commanding Officer of the Scientology Advanced Organization in Los Angeles (AOLA). L. Ron Hubbard gives her a mission to set up a Scientology organization called Celebrity Centre in Los Angeles, with the purpose of "revitalization of the arts." She rents an old redwood and brick warehouse near downtown Los Angeles and begins delivering basic Scientology services to people in the arts, sports, entertainment, and government. She knows Ingo

Swann, and he is instrumental in helping her get Celebrity Centre started. The center also has an art gallery, a performance theatre, and classes in everything from ballet to fencing to fine arts and crafts like pottery and leatherwork.

#### Friday, 10 April 1970

- Richard Helms has rubber-stamped E. Howard Hunt's "early retirement" and has written a letter to Robert R. Mullen on behalf of Hunt, urging Mullen to hire him. Mullen is head of a CIA-created public relations firm in D.C. and has "cooperated" with CIA in the past." One of the Mullen offices, in Stockholm, Sweden, is "staffed, run, and paid for by CIA." Also at the Mullen firm is Douglas Caddy.<sup>[1][38]</sup>



Yvonne Gillham (later Jentzsch) opens Celebrity Centre in Los Angeles

#### Monday, 13 April 1970

- Daniel Ellsberg quits Rand in California, flies to Boston and signs a contract at MIT. He remains, though, a "consultant" for Rand.<sup>[30]</sup>

#### Friday, 1 May 1970

- E. Howard Hunt ostensibly "retires" from CIA. He goes to work for Mullen in D.C. [NOTE: By this time, up to eight people at the Mullen company have been cleared and made witting of Agency ties, mainly in providing CIA cover overseas. Some time shortly after arriving, Hunt is told by Robert Mullen that Mullen is planning to retire before long, and that Douglas Caddy has been selected to run the CIA front company along with Hunt and an unnamed other person after Mullen's retirement.]<sup>[1][48]</sup>

*Four weeks after Hunt's purported retirement from CIA and employment at Mullen, a CIA Covert Security Approval is requested for Hunt under Project QK/ENCHANT.*

#### Tuesday, 5 May 1970

- Daniel Ellsberg flies to Washington, D.C. and is there for three days, flies to St. Louis for a day, then flies back to D.C.<sup>[30]</sup>

#### Wednesday, 13 May 1970

- Daniel Ellsberg testifies before the Senate Foreign Relations Committee hearings, Senator Fulbright chairing.<sup>[30]</sup>

#### Thursday, 28 May 1970

- A CIA Covert Security Approval is requested under Project QK/ENCHANT for E. Howard Hunt.<sup>[49]</sup>

**August 1970**

- Just four months after E. Howard Hunt, James McCord "retires" from CIA.<sup>[50]</sup>

**September 1970**

- Daniel Ellsberg stops seeing Beverly Hills psychiatrist Lewis Fielding. *[NOTE: Ellsberg had moved to Cambridge, Massachusetts months before. See 13 April 1970.]*<sup>[2]</sup>

**Sunday, 20 September 1970**

- L. Ron Hubbard releases OT VII, the highest level in Scientology, to Advanced Organizations around the world.<sup>[3]</sup>



CIA's James McCord

**November 1970**

- Douglas Caddy leaves the Mullen firm to work for Gall, Lane, Powell and Kilcullen, where tax and probate attorney Meade Emory is connected.
- E. Howard Hunt becomes a "client" of Caddy and of Gall, Lane, Powell and Kilcullen. Caddy consults with Hunt regarding probate and other matters.
- G. Gordon Liddy is approached by Robert Mardian, asking Liddy to take a position that Mardian describes as "super-confidential."<sup>[51]</sup>

**1971****January 1971**

- NSA's Hal Puthoff somehow has gotten past L. Ron Hubbard's prohibitions against government spy agency personnel being allowed access to upper-level Scientology, and has progressed up the Scientology levels to the recently-released OT VII—the highest level available. He writes a success story for a Scientology publication about having completed OT VII, saying that on a weekend he had stood outside a locked building and remotely viewed information he wanted from a building directory that he couldn't physically read from the doorway, then verified later, when the building was open, that what he had viewed remotely had been accurate. *[NOTE: According to Scientology's The Auditor magazine, Special Issue March 1971, by that date there are only 2,773 Scientology Clears in the world. Being Clear is a prerequisite to the OT Levels. Even if 10% had gone all the way up through the higher levels by this date, Puthoff would be among only about 300 OT VIIs in the world.]*<sup>[52]</sup>



NSA's Harold "Hal" Puthoff, one of fewer than 3,000 Scientology "Clears" in the world in 1971, has joined the ranks of a much smaller number of OT VIIs.

**February 1971**

- A hidden taping system is installed in the Oval Office of the White House.<sup>[22]</sup>

**April 1971**

- Vietnam vet and Green Beret Paul Preston has signed up in Scientology's Sea Org, and is at the confidential land base for Scientology—"Tours Reception Center," in Tangier, Morocco—where the Flagship *Apollo* often docks with L. Ron Hubbard aboard.

**Saturday, 17 April 1971**

- o E. Howard Hunt is in Miami and meets with Bernard Barker, Eugenio Martinez, and Felipe De Diego. Bernard Barker has a history of almost seven years with CIA. Eugenio Martinez is on "retainer" with CIA. *[NOTE: A little over four months later, these same three men will be involved with Hunt in a purported break-in of the offices of psychiatrist Lewis Fielding, ostensibly in response to Daniel Ellsberg having leaked the Pentagon Papers. But the Pentagon Papers haven't been leaked to the press yet, and won't be for almost two months.]*<sup>[1]</sup>



CIA's Bernard Barker

**May 1971**

- o IRS begins an audit of the senior Scientology corporation, Church of Scientology of California. Meade Emory, who later will corporately restructure all of Scientology, is Legislative Attorney for the Joint Committee on Taxation.<sup>[28]</sup>

**June 1971**

- o Daniel Ellsberg makes "a series of phone calls" to psychiatrist Lewis Fielding "shortly before" the Pentagon Papers are published.<sup>[2]</sup>

**Saturday, 12 June 1971**

- o The day before the "Pentagon Papers" are published, Morton Halperin, Leslie Gelb, and Defense Department official Paul Nitze make "a deposit into the National Archives" of "a whole lot of papers." *[NOTE: This turns out later to be copies of the not-yet-published Pentagon Papers that will make Daniel Ellsberg famous and launch everything that later comes to be known as Watergate.]*<sup>[22]</sup>

**Sunday, 13 June 1971**

- o The New York Times publishes the first of three installments of secret documents that have been passed to Times reporter Neil Sheehan by Daniel Ellsberg. These come to be known as the "Pentagon Papers."

**Tuesday, 15 June 1971**

- o G. Gordon Liddy is abruptly transferred from being "Special Assistant to the Secretary of the Treasury" to "Staff Assistant of the President of the United States," part of the White House Domestic Council. Liddy is supplied with White House credentials.<sup>[53][51]</sup>

**Wednesday, 16 June 1971**

- o G. Gordon Liddy is at the White House in his new job. A William Galbraith comes to the White House, purportedly one of a group of officers from the White House News Photographers Association (WHNPA). *[NOTE: No William Galbraith has been found on WHNPA rolls, and a William Galbraith has been identified as having been a CIA agent. Nine days after this event a girl is found shot to death on board the Scientology Flagship Apollo at Safi, Morocco, and a William Galbraith will be in Safi representing the U.S. Embassy in Morocco in response. See 25 June 1971 and 13 July 1971.]*<sup>[51][54]</sup>

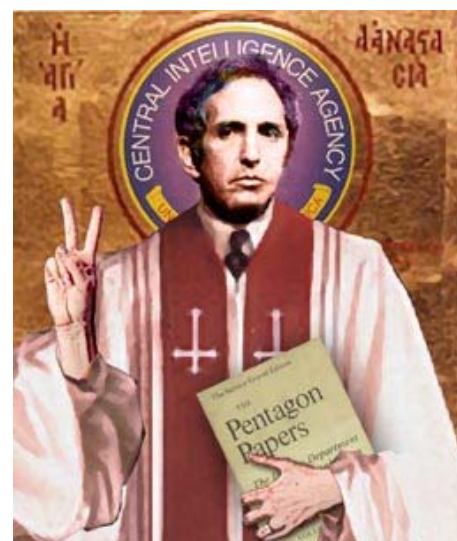

Daniel Ellsberg, having highest possible clearances from CIA, leaks the "Pentagon Papers"

**Friday, 18 June 1971**

- o An unspecified amount of money being carried by John McLean while on a confidential mission from the Scientology Flagship Apollo is reported stolen by McLean. Also with the Apollo at the time is Green Beret Paul Preston. *[NOTE: McLean will later become a key witness for the Commissioner of Internal Revenue against Scientology in the IRS case that results from a tax audit of Scientology being pursued at the time this event takes place. See May 1971.]*<sup>[28]</sup>

**Friday, 25 June 1971**

- One week to the day after John McLean reports Scientology money having been stolen from him, Susan Meister is found shot to death in a cabin aboard the Flagship *Apollo*, docked in Safi, Morocco. Conflicting reports say she was shot either in the mouth or in the forehead. One report says the gun was folded in her hands neatly in her lap. Her death is ruled a suicide by Moroccan authorities.<sup>[46][55][56]</sup>

### Monday, 28 June 1971

- Daniel Ellsberg is indicted for the leak of the Pentagon Papers.

### Wednesday, 30 June 1971

- The Supreme Court rules 6-3 that the government has not shown compelling evidence to justify blocking further publication of the Pentagon Papers.

### July 1971

- Yvonne Gillham, Executive Director of Scientology's Celebrity Centre in Los Angeles, is in regular touch with both Ingo Swann and Hal Puthoff. As Executive Director, as a fellow OT, and as a highly-trained Scientology auditor, she has taken on responsibility for their progress in and connection to Scientology.



Yvonne Gillham at Scientology's Celebrity Centre is closely connected to both Hal Puthoff and Ingo Swann

### Thursday, 1 July 1971

- David Young—who is with NSA, the same agency as OT VII Hal Puthoff—is appointed to the White House Domestic Council to work with Egil Krogh<sup>[57][2]</sup>
- On or about the same date, Carol Ellsberg, Daniel Ellsberg's ex-wife, calls the FBI. She tells them that Daniel Ellsberg had seen a psychiatrist. She says that Ellsberg has "assured her" that he "had told this analyst all about what he had done" (referring to the Pentagon Papers). She volunteers the name of the Beverly Hills psychiatrist: Lewis Fielding. *[NOTE: Daniel and Carol Ellsberg have been living apart since January 1964, divorced since 1966. Daniel Ellsberg didn't begin with Fielding until two years after the divorce, in March of 1968 (see), and had quit seeing Fielding in September 1970 (see)—nearly a year before What he had done.]*
- On or about the same date, John "Jack" Caulfield, Staff Assistant to President Nixon, has created a 12-page political espionage proposal called "Sandwedge." Ostensibly as part of it, Anthony Ulasewicz has rented an apartment at 321 East 48th Street (Apartment 11-C), New York City. G. Gordon Liddy is given the complete "Sandwedge" plan. *[NOTE: The apartment is in close proximity to the lab and school of CIA's Cleve Backster. It provides a backstopped New York address and phone. Note, too, that the reference for date of Sandwedge is a document in the National Archives titled 7/71 Sandwedge proposal," despite most anecdotal accounts placing it later in 1971.]*<sup>[58][59]</sup>



Jack Caulfield

### Friday, 2 July 1971

- CIA Director Richard Helms is pushing behind the scenes to get E. Howard Hunt into a position connected with the White House in response to the Pentagon Papers having been leaked. H. R. Haldeman tells Nixon that that Helms has described Hunt: "Ruthless, quiet and careful, low profile. He gets things done. He will work well with all of us. He's very concerned about the health of the administration. His concern, he thinks, is they're out to get us and all that, but he's not a fanatic. We could be absolutely certain it'll involve secrecy... ."
- Charles Colson sends a memo to H. R. Haldeman with a transcript of a phone conversation he had with E. Howard Hunt the previous day—which he happened to record. Colson says: "The more I think about Howard Hunt's background, politics, disposition and experience, the more I think it would be worth your time to meet him."<sup>[22][1]</sup>

### Wednesday, 7 July 1971

- E. Howard Hunt is hired as a "White House consultant" while keeping his full-time job at Mullen. Hunt is supplied with White House credentials.<sup>[1]</sup>

#### Thursday, 8 July 1971

- E. Howard Hunt has a private meeting with CIA's Lucien Conein, Hunt's acquaintance of almost 30 years. *[NOTE: Conein had been part of the team that Daniel Ellsberg had gone with to Vietnam, headed by CIA's Edward Lansdale [often misspelled as Edward Landsdale], in 1965-66.]*<sup>[1]</sup>

#### Tuesday, 13 July 1971

- A William Galbraith, represented as being American vice consul from Casablanca, meets in Safi, Morocco with two representatives from the Scientology Flagship *Apollo*, ostensibly concerning the 25 June 1971 death of Susan Meister *[see 16 June 1971 re: Galbraith]*.

*A William Galbraith, reportedly CIA,  
is at the Scientology Flagship Apollo in Safi, Morocco  
after having been at the White House a month before,  
ostensibly as a White House news photographer.*

#### Tuesday, 20 July 1971

- E. Howard Hunt has a private meeting with CIA's Edward G. Lansdale [often misspelled as Edward G. Landsdale]. *[NOTE: Lansdale had taken Daniel Ellsberg and Lucien Conein to Vietnam in 1965-66. Green Beret Paul Preston had also been there as part of so-called "pacification" programs, "as well as Neil Sheehan, who just has published the Pentagon Papers.]*<sup>[1]</sup>

#### Thursday, 22 July 1971

- E. Howard Hunt goes to CIA headquarters and meets privately with Deputy Director of CIA Robert Cushman.<sup>[1][60]</sup>

#### Friday, 23 July 1971

- The CIA supplies E. Howard Hunt with counterfeit ID in the name of "Edward J. Warren." Hunt meets CIA's Stephen Greenwood in a CIA safehouse where a fake driver's license and other ID material, plus a disguise, are given to Hunt.<sup>[60][1][61]</sup>

#### Saturday, 24 July 1971

- Based on a memorandum by Egil Krogh and NSA's David Young, the Special Investigations Unit is established at the White House under them. It comes to be known as the White House Plumbers. *[NOTE: David Young gives the unit its nickname, supposedly because it is there to stop leaks. "It never stops a single leak, or accomplishes anything effective regarding security leaks. Liddy and Hunt are already established in their positions weeks before the unit is created. The creation of the Special Investigations Unit does nothing to alter the operational status or position of either of them.]*



NSA's David Young is running everything that leads to the Fielding office break-in. Young will later be given immunity by Watergate prosecutors, then will report the Fielding burglary, backed up by CIA photos, just after CIA has given a secret contract to Hal Puthoff to develop the remote viewing program using OT VII Ingo Swann.

#### Friday, 30 July 1971

- A highly secure facility has been set up in Room 16 of the Old Executive Office Building adjacent to the White House that G. Gordon Liddy and E. Howard Hunt use. It includes a secure phone used "mostly to talk to the CIA at Langley."<sup>[51]</sup>



**Early August 1971**

- o Green Beret and Vietnam veteran Paul Preston is aboard the Flagship *Apollo* in the Mediterranean, where L. Ron Hubbard is living. [NOTE: *Less than a year later, Hubbard disappears, and some sources say Preston is with Hubbard at the time of the disappearance as a bodyguard.* See 28 May 1972.]
- o G. Gordon Liddy is in regular communication with "State and the CIA," having direct conversations with CIA Director Richard Helms. Liddy is briefed by CIA on "several additional sensitive programs in connection with his assignment to the White House staff." Liddy is also making regular trips to the Pentagon.
- o E. Howard Hunt is making regular trips to the State Department. U.S. Ambassador to the United Nations at the time is George H.W. Bush (Sr.).<sup>[62][51][1][34]</sup>

**Monday, 2 August 1971**

- o CIA psychiatrist Bernard Malloy comes to Room 16 and meets privately with G. Gordon Liddy and E. Howard Hunt.<sup>[1][53]</sup>

**Friday, 6 August 1971**

- o E. Howard Hunt again meets clandestinely in a CIA safehouse, this time with CIA's Stephen Greenwood and also with CIA's Cleo Gephart. Hunt purportedly discusses CIA providing a "backstopped address and phone" in New York city. Hunt also asks for CIA to provide phony ID and a disguise for "an associate"—G. Gordon Liddy. [NOTE: *Hunt is asking for ID and disguise for Liddy prior to any proposal to break into Lewis Fielding's office. Also, there's already a backstopped address and phone in New York city at 321 East 48th Street, Apartment 11-C, New York City, set up by Anthony Ulasewicz as part of the Sandwedge proposal, which Liddy and Hunt have. See 1 July 1971.*]<sup>[61]</sup>

*E. Howard Hunt and G. Gordon Liddy  
both are supplied with phony I.D. and disguises"  
by the CIA, and both have been issued  
White House credentials.*

**Wednesday, 11 August 1971**

- o CIA psychiatrist Bernard Malloy again comes to Room 16 and meets privately with G. Gordon Liddy and E. Howard Hunt. Soon after, Liddy and Hunt recommend an attempt at surreptitious entry for "acquisition of psychiatric materials" on Daniel Ellsberg from the files of psychiatrist Lewis Fielding. They claim the need, first, for a "feasibility study" of Fielding's Beverly Hills office.<sup>[1][53]</sup>

**Thursday, 12 August 1971**

- o L. Ron Hubbard issues a policy letter called "Advanced Courses" that makes access to all the confidential upper levels of Scientology available by invitation only, to be based largely on ethics record in Scientology and security of materials.<sup>[63]</sup>

**Friday, 20 August 1971**

- o The CIA supplies G. Gordon Liddy with counterfeit ID in the name of "George F. Leonard." Hunt and

Liddy meet CIA's Stephen Greenwood (called "Steve" in Hunt's account) in a CIA safehouse where a CIA-created fake driver's license and other ID material, plus a disguise, and a camera are issued to Liddy. *[NOTE: According to Greenwood, Hunt and Liddy say they have to stop by the Pentagon on their way to the airport, although they don't say where they are going. It isn't to Los Angeles for the Fielding office feasibility study, since that doesn't take place until 26 August 1971 (see) according to the available accounts from Hunt and Liddy, cited in this timeline.]*<sup>[60][1][61]</sup>

#### Thursday, 26 August 1971

- E. Howard Hunt and G. Gordon Liddy fly to Los Angeles. Hunt takes pictures of Liddy, in his CIA-issued black wig, standing in front of psychiatrist Lewis Fielding's office door, with Fielding's name on the door. Liddy also takes pictures of Hunt. The photos are taken with the camera supplied to them by CIA.<sup>[51][1][64]</sup>

#### Friday, 27 August 1971

- E. Howard Hunt and G. Gordon Liddy fly back to Washington, D.C. CIA's Stephen Greenwood meets them at the airport, where Hunt gives Greenwood the film for developing by CIA. Greenwood delivers prints to Hunt the same day. The CIA keeps a copy of the photos of Liddy and Hunt (in CIA-provided "disguises" that don't disguise them at all) mugging in front of Lewis Fielding's identifiable door. *[NOTE: The CIA later turns their copies of the photos over to Watergate investigators, which results in all criminal charges against Daniel Ellsberg for leaking the Pentagon Papers to be dropped. See 1973, specifically 3 January, 17 March, 15 April, and 11 May 1973]*<sup>[60][1][61]</sup>



Hunt and Liddy take photographs of each other in front of Fielding's door in CIA-supplied "disguises." The photos will later be used by CIA to give Ellsberg a convenient "Get Out of Jail Free" card.

#### Saturday, 28 August 1971

- On a Saturday, Hunt and Liddy purportedly are in Room 16 when Liddy tells Hunt that the plan to do a break-in of Fielding's office is approved, but that the two of them are not "to be permitted anywhere near the target premises." *[See 27 August 1971, immediately above.]* E. Howard Hunt then purportedly calls Bernard Barker in Miami and asks if Barker can "put together a three-man entry team." Barker calls back to say it will be Barker, Eugenio Martinez, and Felipe De Diego. *[NOTE: As luck would have it, this happens to be the same three men Hunt had met with in Miami two months before the Pentagon Papers were published. See 17 April 1971.]*<sup>[1][51][65]</sup>



CIA's Eugenio Martinez

#### Friday, 3 September 1971

- A break-in takes place at the office of psychiatrist Lewis J. Fielding in Beverly Hills, California. The break-in is made obvious by the smashing of a window. Accounts of the break-in are irreconcilably conflicting. According to Bernard Barker, E. Howard Hunt, and G. Gordon Liddy, the three Cubans—Barker, Martinez, and De Diego—had entered the office and searched thoroughly, and there was no file on Daniel Ellsberg anywhere. According to Lewis Fielding, there was a file on Ellsberg in his office, which Fielding says he found on the floor the next morning. Fielding claims it was evident that someone

had gone through the file.

- The same night, Hunt and Liddy are in New York City—where Hunt has made an issue of needing "a backstopped address." They check into the Pierre hotel and remain in New York through at least Sunday, 5 September 1971. *[NOTE: There is no physical evidence that either Liddy or Hunt had been in Los Angeles at all for the Fielding office break-in. Only the anecdotal claims of the co-conspirators account for the whereabouts of Hunt and Liddy that weekend. This is similar to the later purported Watergate first break-in that involved the same personnel. (See 26, 27, and 28 May 1972.) Also, there is a backstopped address that was available to Liddy and Hunt in New York: 321 East 48th Street, not far from the Pierre hotel. Both locations are less than a mile from the Times Square lab and polygraph school of CIA's Cleve Backster. Five days after Hunt and Liddy leave New York (see 9 September 1971), OT VII Ingo Swann will 'chance' to meet Backster 'at a party' in New York. Backster will be the person who then ostensibly sets up a connection between Ingo Swann—a Scientology OT VII—and NSA's Hal Puthoff, also a Scientology OT VII. Both will be contracted by CIA to start CIA's secret remote viewing program (see 1 October 1972).]*<sup>[1][51][65]</sup>



Liddy and Hunt in New York on same night as Fielding break-in in Los Angeles

#### Thursday, 9 September 1971

- OT VII Ingo Swann meets CIA's Cleve Backster, purportedly "at a party" in New York. Backster has an "extensive network of contacts in law enforcement agencies and within the CIA."<sup>[44]</sup>

#### Sunday, 12 September 1971

- OT VII Ingo Swann visits Cleve Backster's lab and polygraph school in New York city where Swann is asked to think thoughts of harming a plant that Backster has connected up to what Swann says was "a polygraph." Swann thinks of lighting a match with the intent of burning one of the plant's leaves, and there is an immediate and violent reaction. With repetitions, the reaction diminishes, and the conclusion is drawn that not only is the plant capable of detecting harmful thought, but can "learn" to differentiate between true and artificial intent. The thought directed at the plant is changed to one of putting acid in its pot, with the same curve of results.<sup>[44]</sup>



OT VII Ingo Swann

#### Wednesday, 15 September 1971

- A "Master File" of cables (telexes) disappears from the External Comm Bureau of the Scientology Flagship *Apollo*. The file contains all cables related to the administration of Scientology worldwide from 22 August 1971 to 15 September 1971. In the External Comm Bureau at the time is John McLean. Also aboard he ship is Green Beret Paul Preston, doing a service called "Word Clearing Method 1."<sup>[62]</sup>
- E. Howard Hunt makes a request that the CIA "immediately recall a 24-year-old secretary" from Paris for his use and "explain to all concerned that she was urgently needed for an unspecified special assignment."<sup>[2]</sup>

#### Monday, 20 c. September 1971

- E. Howard Hunt is granted special permission by the State Department for "full access to the department's chronological cable files." *[NOTE: Shortly thereafter, Hunt is engaged in forging cables.]*<sup>[1]</sup>

#### Saturday, 25 September 1971

- Scientology OT VII Ingo Swann is doing experiments with Cleve Backster involving a piece of graphite hooked into a Wheatstone bridge [the main mechanism in a Scientology e-meter], connected with a chart recorder. Swann learns that he can focus a "beam" of intention at the graphite, and cause repeatable jogs in the chart.<sup>[44]</sup>

**October 1971**

- E. Howard Hunt is in telephone contact with CIA Chief European Division John Hart, and has several telephone conversations with CIA Executive Officer European Division John Caswell.<sup>[34]</sup>

**Friday, 1 October 1971**

- Dr. John Wingate of the American Society for Psychical Research (ASPR) in New York invites OT VII Ingo Swann to work on "well-designed" psychic experiments with psychiatrist Karlis Osis. Osis is a member of the very anti-Scientology American Psychological Association (APA). *[NOTE: Chicago's W. Clement Stone is a member and major contributor to the ASPR. About 7 months later, CIA's E. Howard Hunt will deliver an undisclosed amount of cash in a sealed envelope to the W. Clement and Jessie V. Stone Foundation in Chicago. See April 1972.]*<sup>[44]</sup>



APA's Karlis Osis

**Sunday, 10 October 1971**

- Cleve Backster writes and circulates a small report entitled "Psychokinetic Effects on Small Samples of Graphite," detailing the repeatable experiments that he has conducted with OT VII Ingo Swann. Backster tells Swann, "Boy, are the guys down at the CIA going to be interested in you."<sup>[44]</sup>

**Friday, 15 October 1971**

- E. Howard Hunt meets with CIA Director Richard Helms.
- Ingo Swann meets with Gertrude Schmeidler, who asks Swann if he thinks he can influence a thermistor isolated in a sealed thermos bottle. He agrees to try.<sup>[44][38]</sup>

**Late October 1971**

- Scientology OT VII Ingo Swann is in Washington, D.C. with "a colleague" meeting "in bars and pizza parlours" with unnamed intelligence personnel. At one of the meetings with "six spooks," Swan is asked: "If you were going to set up a threat analysis program to match what the Soviets are up to, what would you do?"<sup>[66]</sup>

*By late October 1971  
Ingo Swann is in Washington, D.C. meeting with U.S.  
intelligence agency personnel.*

**Saturday, 30 October 1971**

- Ingo Swann is working with CIA's Cleve Backster, testing "psi probes" on gasses in pressurized containers. He and Backster move on to experiments with biologicals, including one-celled biological specimens, blood, and seminal fluid. When Swann has some success in affecting biologicals with psychic probing, Backster says, "Well, you've just done something the Soviets have been working on for a long time."<sup>[44]</sup>

**Early November 1971**

- CIA's James McCord, purportedly retired in August 1970, signs a contract with the Republican National Committee to handle "security." The contract is in the name of "McCord Associates, Inc." *[NOTE: The corporation will not be created until several weeks after the contract is signed; incorporation papers are not filed until 19 November 1971 (see) in Maryland.]*<sup>[67]</sup>

**Monday, 15 November 1971**

- Dr. Gertrude Schmeidler conducts her thermistor experiments with OT VII Ingo Swann at the New York City College. Swann can produce changes in the target thermistors, while the control thermistors remained unchanged, on a repeatable basis at the direction of the experimenter.<sup>[44]</sup>



Gertrude Schmeidler

**Friday, 19 November 1971**

- CIA's E. Howard Hunt contacts CIA's Office of Security Director Robert Osborne.<sup>[38]</sup>
- CIA's James McCord files incorporation papers in Maryland for McCord Associates, Inc., ostensibly a security company, but the incorporation papers say nothing about providing security, and the company is not licensed for security. Included on the board are McCord, his wife, and his sister, Dorothy Berry, who works for an "oil company in Houston." [NOTE: *Berry later claimed she had the idea she had been listed on the board. Also, the Gulf Resources and Chemical Corporation—an oil company in Houston that controls half the world's supply of lithium—will later provide checks that get converted to traceable \$100 bills for part of what becomes known as Watergate. See 15 April 1972.*]<sup>[67]</sup>

**Monday, 22 November 1971**

- OT VII Ingo Swann is involved in one of a series of ten out-of-body (OOB) perception experiments at ASPR, the task being to verbally describe objects out of his sight in a target tray. Having difficulty doing a narrative description of the target items, he hits upon the idea of doing sketches. Successful, this becomes a regular part of the experiments.<sup>[44]</sup>

**Wednesday, 1 December 1971**

- Gertrude Schmeidler's paper, "PK Effects Upon Continuously Recorded Temperature," describes results of her thermistor experiments with Ingo Swann and is being circulated for peer review. It generates speculation that if someone could trigger a thermistor, they also might be able to remotely trigger a bomb. There are requests for interviews of Schmeidler and Swann from media like *Time* and *Newsweek*, but Swann refuses.<sup>[44]</sup>

**Monday, 6 December 1971**

- G. Gordon Liddy becomes General Counsel to the Committee for the Re-Election of the President.<sup>[68][51]</sup>

**Wednesday, 8 December 1971**

- In one of a series of long-distance remote viewing experiments at ASPR, OT VII Ingo Swann suggests calling the experiments "remote sensing" or "remote viewing."<sup>[44]</sup>
- E. Howard Hunt is in touch with senior CIA officer Peter Jessup, who is with the National Security Council staff.<sup>[38]</sup>
- On or about the same day, Hunt meets privately again with CIA's Lucien Conein.<sup>[1]</sup>

**Sunday, 12 December 1971**

- NSA's David Young meets with Egil Krogh and CIA psychiatrist Bernard Malloy.<sup>[2]</sup>

**Thursday, 16 December 1971**

- CIA's E. Howard Hunt is in Dallas, Texas—an airline hub.
- Lt. George W. Bush is living in Houston, Texas. He is a pilot trained on T-38 Talons, a type of plane used as a chase plane.<sup>[69]</sup>



Lt. George W. Bush

**Thursday, 30 December 1971**

- An "out-of-body" (OOB) perception experiment results in Ingo Swann sketching the target object (a 7-Up can) upside down, so he believes he has missed getting it. Dr. Osiris realizes that it is a perfect drawing of the can once it is turned upside down.<sup>[44]</sup>

## 1972

### January 1972

- G. Gordon Liddy and E. Howard Hunt are collaborating on a "political espionage" plan to replace the Sandwedge proposal. One of the items they have factored into the budget, ostensibly for "political espionage," is a chase plane.<sup>[1][51]</sup>

### Monday, 10 January 1972

- G. Gordon Liddy is in New York city at the apartment Ulasewicz has established at 321 East 48th Street, Apartment 11-C.<sup>[70][51]</sup>

### Wednesday, 12 January 1972

- G. Gordon Liddy is still in New York city. Ingo Swann learns that "two men in suits," flashing credentials, have visited the ASPR facility investigating him. They have met with Dr. Osis, and have looked at the experiment rooms and some of the experiment results. Osis tells Swann that he (Osis) isn't "free to tell" Swann what was discussed.<sup>[44]</sup>



T-38 Talon, commonly used as "chase plane"

### Friday, 14 January 1972

- Origin date of Defense Intelligence Agency (DIA) report, "Controlled Offensive Behavior—USSR"<sup>[71]</sup>

### Tuesday, 25 January 1972

- Buell Mullen tells Ingo Swann that a small group of her "high-placed friends" has begun establishing a pool of money for Swann. Already some \$70,000 has been "pledged" from "several sources."<sup>[44]</sup>

### Monday, 31 January 1972

- "Information Cut-off Date" for a 1972 Defense Intelligence Agency (DIA) report entitled "Controlled Offensive Behavior—USSR" concerning Soviet research and development of "psi" technologies.<sup>[71]</sup>
- E. Howard Hunt and G. Gordon Liddy return from a weekend trip to Los Angeles, during which Liddy also has gone to San Diego and back. [NOTE: Dr. Augustus B. Kinzel has a home just outside San Diego.]<sup>[1][51]</sup>

*The secret DIA report,  
Controlled Offensive Behavior—USSR will say  
when published that Soviet knowledge in parapsychology  
is superior to that of the U.S."*

### Early February 1972

- Buell Mullen calls Ingo Swann to say that Dr. Augustus B. Kinzel will be in New York city on 17 February with "some friends" who want to meet with Swann. She is having a dinner party for the occasion. Swann says he'll be there.<sup>[44]</sup>
- G. Gordon Liddy and E. Howard Hunt fly to Miami, home of Bernard Barker and other CIA-connected Cubans.<sup>[1][51]</sup>
- G. Gordon Liddy "recruits" CIA's James McCord as a "wire man," purportedly to be able to do electronic eavesdropping for "political espionage" purposes. [NOTE: At the time, Liddy has no approved budget for any such activities, nor are there any approved plans for, or targets for, any such activities.]<sup>[53]</sup>

**Thursday, 17 February 1972**

- At a dinner at Buell Mullen's home in New York, Dr. Augustus B. Kinzel has brought four "friends" in suits who Kinzel will only introduce to Swann by first names. They have a one-hour meeting that is "strictly confidential," concerning "big-time funding for a new research organization" that's separate from the \$70,000 already collected. According to Swann, at least one of the "friends" is CIA.<sup>[44]</sup>
- On or about the same date, E. Howard Hunt and G. Gordon Liddy again fly to Miami, ostensibly to meet with Donald Segretti (a.k.a. "Donald Simmons"). While there, Hunt is in contact with CIA's Bernard Barker.



Guess Who's Coming to Dinner

**Tuesday, 22 February 1972**

- OT VII Ingo Swann performs the first of a series of "out-of-body" (OOB) experiment with Vera Feldman of the ASPR as the outbound experimenter. Swann is hooked up to brainwave leads and locked in the OOB room while Feldman goes to the Museum of Natural History a few blocks away. Swann gets a high number of "hits" on what Feldman is seeing, one of them being a display case full of gemstones. Swann and Feldman talk about ESP being used for psychic spying.<sup>[44]</sup>
- G. Gordon Liddy meets with CIA in connection with CIA "special clearances" he has been granted.<sup>[34]</sup>



Liddy and Hunt name the operations they are engaged in "GEMSTONE"

**Thursday, 24 February 1972**

- G. Gordon Liddy and E. Howard Hunt meet with a "retired" CIA doctor, introduced by Hunt to Liddy as "Dr. Edward Gunn," to get briefed by him on various covert means of murder for a possible assassination. *[NOTE: Although Liddy and Hunt relate many similar incidents, if disjointedly, in their respective autobiographies, Hunt mentions nothing about this incident in his, while Liddy devotes several pages to it.]*

**Late February 1972**

- OT VII Ingo Swann, connected with ASPR, meets Robert D. Ericsson, Executive Director of Spiritual Frontiers Fellowship (SFF). *[NOTE: Chicago's W. Clement Stone is a member and major contributor to both the SFF and ASPR. About two months later, E. Howard Hunt will deliver an undisclosed amount of cash in a sealed envelope to the W. Clement and Jessie V. Stone Foundation in Chicago. See April 1972.]*<sup>[44]</sup>
- One of the members of the board of ASPR, A.C. Twitchell, Jr., purportedly calls Ingo Swann early in the morning saying that there is a move afoot at the ASPR to have Swann ejected on the grounds that he is a Scientologist. Twitchell says that it has been circulating that Swann is "Hubbard's spy," and is seeking to take over the ASPR on Hubbard's behalf. Swann threatens to sue the board over his civil rights.<sup>[44]</sup>
- E. Howard Hunt travels to Nicaragua on an "undisclosed mission." *[NOTE: See entry for 3 March 1972.]*<sup>[38]</sup>

**Wednesday, 1 March 1972**

- Russell Targ, Charles T. Tart, and David Hart release a proposal entitled "Research on Techniques to Enhance Extra Sensory Perception."<sup>[44]</sup>
- On or about the same date, Douglas Caddy begins to do "legal tasks" for G. Gordon Liddy.<sup>[72]</sup>

**Friday, 3 March 1972**

- Gary O. Morris, psychiatrist of E. Howard Hunt's wife, Dorothy, vanishes while on vacation on the Caribbean island of St. Lucia. No trace is ever found of the pleasure boat he had left on for a cruise with his wife and a local captain, Mervin Augustin.<sup>[38]</sup>

**Wednesday, 15 March 1972**

- A memorandum is sent to Director of FBI J. Edgar Hoover from the Legal Attaché (LEGAT) Copenhagen titled "SUBJECT: L. RON HUBBARD." It says: "On 3/13/72, [BLACKED OUT] advised that he has not yet completed preparation of his report concerning the Scientology Organization and its operations in Denmark. He reiterated, however, that when completed a copy of this report will be designated for [BLACKED OUT] Contact will be maintained with [BLACKED OUT] in order to insure that this office receives copies of his report and Bureau will be kept advised."<sup>[73]</sup>

#### Monday, 20 March 1972

- OT VII Ingo Swann is at Cleve Backster's lab in New York. Backster hands some papers to Swann on Hal Puthoff and purportedly says, "You two might get along. He's into Scientology, too." *[NOTE: Both Hal Puthoff and Ingo Swann have been connected with Yvonne Gillham at Celebruty Centre for some time. Both also are OT VII, and the only place in the United States delivering the OT Levels is the Advanced Organization in Los Angeles (AOLA), where Yvonne Gillham had been the senior executive before starting Celebruty Centre.]*<sup>[44]</sup>

#### Wednesday, 22 March 1972

- Janet Mitchell writes regarding out-of-body brightness comparison experiments with Ingo Swann, saying, "It may be possible that he can see all the waves in the atmosphere from infrared to ultraviolet."<sup>[44]</sup>

#### Monday, 27 March 1972

- G. Gordon Liddy's job abruptly changes to general counsel of the Finance Committee to Re-elect the President.<sup>[53]</sup>

#### Wednesday, 29 March 1972

- Two days after Liddy's job changes, E. Howard Hunt "terminates" in his paid capacity as a White House consultant—yet he keeps his office and the safe he'd used as such, and keeps his White House credentials because he continues to "work there a few hours each week."<sup>[22][1]</sup>

#### Thursday, 30 March 1972

- The day after E. Howard Hunt's "official" disconnection from the White House, OT VII Ingo Swann contacts OT VII Hal Puthoff saying Cleve Backster has "suggested" for Swann to contact Puthoff. Swann has several phone conversations over several days with Puthoff, who suggests that Swann come out to Stanford Research Institute (SRI) for a couple of weeks to do some experiments.<sup>[44]</sup>

#### Early April 1972

- CIA's E. Howard Hunt flies to Chicago and delivers an undisclosed amount of cash in a sealed envelope to W. Clement and Jessie V. Stone Foundation.<sup>[1]</sup>

#### Tuesday, 4 April 1972

- OT VII Ingo Swann receives word that an independent judge, blind to the fact that she was judging an experiment in out-of-body (OOB) perceptions, has correctly matched all eight of the former "picture drawing" trials—a 100 per cent match between the OOB drawings and the contents of the target trays.<sup>[44]</sup>



Unknown amount of cash delivered by CIA's E. Howard Hunt to offices of W. Clement Stone's foundation

#### Friday, 7 April 1972

- L. Ron Hubbard gives three taped lectures to students on the Expanded Dianetics course. They are the last public lectures Hubbard ever will give. *[NOTE: As of this date, L. Ron Hubbard had given over 1,300 public lectures since 1950—averaging a little over one a week.]*



**Monday, 10 April 1972**

- A court ruling this date by the United States Court of Appeals, Eighth Circuit, in St. Paul, Minnesota, allows the U.S. federal government to keep a shipment of Scientology e-meters that had been seized by the Department of Health, Education and Welfare on the basis of "improper labelling," putting an unknown number of e-meters in permanent custody and possession of federal agencies.<sup>[74]</sup>



A timely Minnesota court ruling puts a shipment of Scientology E-meters into permanent federal custody and control

**Saturday, 15 April 1972**

- E. Howard Hunt and G. Gordon Liddy fly to Miami and deliver checks drawn on a Mexico City bank to CIA's Bernard Barker. *[NOTE: Several of the checks have originated from Gulf Resources and Chemical Corporation in Houston, which at the time controls half the world's supply of lithium, used in the making of hydrogen bombs and in psychiatric drugs.]*<sup>[1]</sup>

**Monday, 17 April 1972**

- Physicist Dr. Russel Targ meets with CIA personnel from the Office of Strategic Intelligence (OSI) and discusses the subject of paranormal abilities. Films of Soviets moving inanimate objects by mental powers are made available to analysts from OSI.<sup>[19]</sup>

**Thursday, 20 April 1972**

- CIA Office of Strategic Intelligence personnel who have been briefed by Russell Targ contact personnel from the Office of Research and Development (ORD) and Technical Services Division (TSD) regarding films and reports of Soviet investigations into psychokinesis. *[NOTE: Although the name of CIA's Technical Services Department (TSD) later changes to Office of Technical Services (OTS), some sources anachronistically refer to TSD as OTS when it was still TSD. The name isn't officially changed until November 1972.]*<sup>[19]</sup>

**Monday, 24 April 1972**

- CIA's Bernard Barker cashes a cashier's check for \$25,000 at his bank in Miami. *[NOTE: This \$25,000, from the Dahlberg check, plus two later withdrawals by Barker will equal \$114,000. See 2 May and 8 May 1972.]*<sup>[75][76]</sup>

**Monday, 1 May 1972**

- Russell Targ has joined the Stanford Research Institute, and is visited by a CIA Office of Research and Development (ORD) Project Officer. Targ proposes that some psychokinetic verification investigations can be done at SRI in conjunction with Scientology OT VII Hal Puthoff.<sup>[19]</sup>
- CIA's James McCord contacts an ex-FBI agent, Alfred Baldwin, who is living in Connecticut. McCord purportedly doesn't know Baldwin, but wants Baldwin to come to Washington, D.C. that night.<sup>[77]</sup>



J. Edgar Hoover found dead

**Tuesday, 2 May 1972**

- FBI Director J. Edgar Hoover is found dead in his home in the early morning hours. L. Patrick Gray—who has no background in law enforcement—is appointed as Acting Director of FBI. *[NOTE: Hoover's death is attributed to a heart attack, and no autopsy is done. L. Patrick Gray later will destroy material taken from the White House safe of E. Howard Hunt, then will resign.]*
- CIA's Bernard Barker withdraws an unspecified amount of cash from his bank in Miami. *[NOTE: This is*

*the second of three transactions by Barker that will total \$114,000.*<sup>[75]</sup>

- o Alfred Baldwin meets with James McCord. McCord issues Baldwin a Smith & Wesson .38 snub-nose revolver. Baldwin is assigned to travel as a bodyguard with Martha Mitchell on "a trip to the midwest."<sup>[77]</sup>

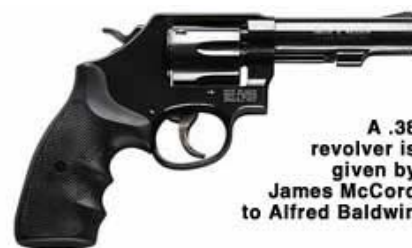

### Wednesday, 3 May 1972

- o OT VII Ingo Swann performs an experiment that he says "scared the bejesus out of the experimenters, and parapsychology as well." In it, Swann perceives not just things the two outbound "beacons" are seeing, but also senses confusion in them. When they come back and confirm that they had gotten lost in some construction work being done in the Museum of Natural History, one says with concern, "Does this mean you can read our minds, too?"<sup>[44]</sup>
- o CIA's Bernard Barker, Eugenio Martinez, Frank Sturgis, and Filipe De Diego arrive in Washington, D.C. from Miami and meet with G. Gordon Liddy and E. Howard Hunt.<sup>[65][1]</sup>

### Thursday, 4 May 1972

- o Lt. George W. Bush is ordered to "report to commander, 111 F.I.S., Ellington AFB, not later than (NLT) 14 May, 1972." [NOTE: Bush does not report as ordered. See 19 May 1972.]<sup>[78]</sup>

### Friday, 5 May 1972

- o CIA's James McCord rents room 419 of the Howard Johnson's motel across the street from the Watergate. The room is registered in the name of McCord Associates.<sup>[79]</sup>

### Monday, 8 May 1972

- o Alfred Baldwin returns to Washington, D.C. from his trip with Martha Mitchell. He is told by James McCord to keep the .38 revolver because "he might be going on another trip."<sup>[77]</sup>
- o G. Gordon Liddy, in D.C., calls CIA's Bernard Barker in Miami.<sup>[79]</sup>
- o Bernard Barker withdraws another unspecified amount of cash from his bank in Miami which, with two other transactions, now totals \$114,000.<sup>[75]</sup>
- o James McCord receives \$4,000 in cash from G. Gordon Liddy.<sup>[80]</sup>

### Tuesday, 9 May 1972

- o Alfred Baldwin leaves Washington, D.C., ostensibly going to his home in Connecticut to "get more clothes." He takes the .38 revolver with him, purportedly because he has been told by James McCord that he might be going on another trip with Martha Mitchell that is scheduled for 11 May 1972. [NOTE: Baldwin doesn't return until 12 May 1972.]<sup>[77]</sup>



Though not all in this timeline, cash pay-outs to CIA's James McCord will total at least \$71,000

### Wednesday, 10 May 1972

- o CIA's James McCord is in Rockville, Maryland. He pays \$3,500 cash for a "device capable of receiving intercepted wire and oral communications." [NOTE: Rockville, Maryland is about six miles from Laurel, Maryland. Five days later presidential candidate George Wallace will be shot in Laurel, Maryland by Arthur Bremer with a .38 caliber revolver. See 15 May 1972.]

### Friday, 12 May 1972

- o Alfred Baldwin returns to Washington, D.C. James McCord tells Baldwin he won't be going with Martha Mitchell so he can "turn in his gun." Baldwin purportedly gives the .38 revolver to McCord. McCord tells Baldwin to move from the the Roger Smith hotel, where Baldwin has been staying, into room 419 at the Howard Johnson's motel.<sup>[77]</sup>

**Monday, 15 May 1972**

- Presidential candidate George Wallace is shot by Arthur Bremer in Laurel, Maryland, ending his presidential campaign and partially paralyzing him.



Presidential candidate George Wallace is shot in Laurel, Maryland with a .38 revolver

**Wednesday, 17 May 1972**

- CIA's Bernard Barker makes two calls from Miami to G. Gordon Liddy, and two calls to CIA's E. Howard Hunt.<sup>[79]</sup>
- A memorandum is sent to Acting Director of FBI L. Patrick Gray from the Legal Attaché (LEGAT) Madrid titled "SUBJECT: L. RON HUBBARD FPC." It says: "Enclosed for information and completion of Bureau and Legat, Copenhagen files is one copy of a memorandum dated 4/26/72, received from the [BLACKED OUT]."<sup>[73]</sup>

**Friday, 19 May 1972**

- Lt. George W. Bush (Jr.) contacts a superior officer in the reserves to discuss "options of how Bush can get out of coming to drill from now through November." The memo recording the conversation says that Bush "is working on another campaign for his dad." The memo writer thinks Bush is "also talking to someone upstairs." [NOTE: *George H. W. Bush (Sr.) is U.S. Ambassador to the U.N. at this time.*]<sup>[81]</sup>
- President Richard M. Nixon, about to embark on an historic trip to the Soviet Union, writes the following in a letter to Henry Kissinger and Alexander Haig: "The performance in the psychological warfare field is nothing short of disgraceful. The mountain has labored for seven weeks and when it finally produced, it produced not much more than a mouse. Or to put it more honestly, it produced a rat. We finally have a program now under way but it totally lacks imagination and I have no confidence whatever that the bureaucracy will carry it out. I do not simply blame (Richard) Helms and the CIA. After all, they do not support my policies because they basically are for the most part Ivy League and Georgetown society oriented."<sup>[82]</sup>
- E. Howard Hunt makes two calls to Bernard Barker in Miami.



Ambassador to UN George H.W. Bush will become CIA Director, then President

<sup>[79]</sup>

**Saturday, 20 May 1972**

- Richard Nixon leaves Washington, D.C. on his trip to Austria, the Soviet Union, Iran, and Poland. He will not return until 1 June 1972.<sup>[83]</sup>
- James McCord sends Alfred Baldwin to Andrews Air Force Base, where Nixon is leaving on *Air Force One*, purportedly because there might be demonstrations and McCord wants Baldwin to be there for more "surveillance activities." [NOTE: *The reason supplied by McCord in testimony for this trip by Baldwin is too thin to slice, particularly in light of the amount of security surrounding Nixon's departure. Besides Air Force One, there is a fleet of White House planes at Andrews for use by VIPs and various staff connected with the White House.*]
- On or about the same day, CIA's E. Howard Hunt flies to Miami and meets with Bernard Barker.<sup>[1]</sup>

**Monday, 22 May 1972**

- Richard Nixon arrives in Moscow and is toasting Soviet leaders at a dinner.<sup>[83]</sup>
- The CIA "Cuban contingent" arrives in Washington, D.C. from Miami: Bernard Barker, Frank Sturgis, Eugenio Martinez, and Virgilio Gonzalez. They are in D.C. purportedly to carry out a "first break-in" on the following weekend of Democratic National Committee headquarters at the Watergate with G. Gordon Liddy, CIA's E. Howard Hunt, and CIA's James McCord. *[NOTE: There is no physical evidence that any such first break-in ever took place. For full coverage, see [Watergate first break-in](#). Note also that while E. Howard Hunt claims that six Cubans arrived on 22 May 1972, the referenced criminal appeals court ruling names only four.]*<sup>[84]</sup>



CIA's Frank Sturgis

**Tuesday, 23 May 1972**

- A memorandum is sent to Acting Director of FBI L. Patrick Gray from the Legal Attaché (LEGAT) Copenhagen titled "SUBJECT: L. RON HUBBARD FPC." It says: "Mr. Victor Wolf, Jr., U.S. Consul, American Embassy, Copenhagen, advised on 5/15/72 that he has not yet found time to prepare the report referred to in relet concerning the Scientology Organization. Mr. Wolf stated that he hopes to devote attention to this matter in a short time. This case will be placed in Pending Inactive status for a period of 90 days."<sup>[73]</sup>
- Alfred Baldwin leaves Washington, D.C. again, purportedly going to his home in Connecticut again. No reason is given for his departure.<sup>[77]</sup>

**Friday, 26 May 1972**

- G. Gordon Liddy, Alfred Baldwin, CIA's E. Howard Hunt, CIA's James McCord, and several Cuban CIA contract agents purportedly are engaged in a failed attempt to break into the Watergate—the "Ameritas dinner" attempt. *[NOTE: But see [Watergate first break-in](#).]*



CIA's Virgilio Gonzalez

**Saturday, 27 May 1972**

- G. Gordon Liddy, Alfred Baldwin, CIA's E. Howard Hunt, CIA's James McCord, and several Cuban CIA contract agents purportedly are engaged in a second failed attempt to break into the Watergate. *[NOTE: But see [Watergate first break-in](#).]*

**Sunday, 28 May 1972**

- G. Gordon Liddy, Alfred Baldwin, CIA's E. Howard Hunt, CIA's James McCord, and several Cuban CIA contract agents purportedly are engaged in a successful "first break-in" at DNC headquarters at the Watergate. According to their later claims, McCord placed two electronic bugs in the DNC headquarters during the "first break-in," and Bernard Barker purportedly had photos taken of the office of the Chairman, Lawrence O'Brien, and of documents on his desk. *[NOTE: There is no physical evidence that any such first break-in ever took place, or the purported two earlier failed attempts on the same holiday weekend. Barker later testified that he never was in O'Brien's office at all, and a telephone company sweep found no electronic bugs in the DNC at all (see 15 June 1972). For full coverage, see [Watergate first break-in](#). There is nothing to account for the whereabouts of Liddy, Hunt, McCord, and Baldwin over the entire Memorial Day Weekend except the conflicting and contradictory anecdotal accounts of the co-conspirators themselves, which they volunteered when 'caught' inside the building on 17 June 1972 (see). See also 3 September 1971 for similarities in the purported Fielding office break-in, including personnel involved and the use*



There apparently was no "first break-in" at the Watergate. Then where were Liddy, Hunt, McCord, and Baldwin over Memorial Day weekend? AWOL with Lt. Bush?

- of a holiday weekend, in that case the Labor Day weekend.]*
- o The crew of the Scientology Flagship *Apollo* are told that L. Ron Hubbard has "moved onshore." His "bodyguard" purportedly is Green Beret Paul Preston. *[NOTE: From this date until his reported death in 1986, L. Ron Hubbard never makes another public appearance. His whereabouts generally are unknown except to a few close people, who later claim that while with them he had been either in hiding or on the run or ill the entire time, including donning various disguises.]*<sup>[85][62]</sup>



On the same weekend as the purported Watergate "first break-in," L. Ron Hubbard goes absent from his usual duties and activities in the company of Green Beret Paul Preston. He's reported to have "moved ashore."

### Monday, 29 May 1972 (Memorial Day)

- o Ingo Swann is told by psychiatrist Karlis Osis that there are to be "no more remote viewing experiments at the ASPR." No reason is given. Swann calls fellow Scientology OT VII Hal Puthoff at SRI and offers to come out.<sup>[83][77][51][44]</sup>

### Sunday, 4 June 1972

- o OT VII Ingo Swann flies from New York to San Francisco, where he is met by OT VII Hal Puthoff and taken to SRI.<sup>[44]</sup>

### Tuesday, 6 June 1972

- o Ingo Swann mentally affects a supercooled magnetometer encased in solid concrete five feet beneath the foundation of the Varian Hall of Physics, Stanford University, witnessed by Dr. Arthur Hebbard, Dr. Marshal Lee, and representatives of CIA.<sup>[44]</sup>

### Wednesday, 7 June 1972

- o Willis Harmon meets OT VI Ingo Swann at SRI and takes Swann to a meeting where there are 16 people. Harmon is Director of his own Educational Policy Research Center at SRI, a center for "Futurology." At the time, futurology constitutes one of the most important and biggest efforts in the world, and Harmon is well connected in Washington, D.C., with offices there. Harmon explains to Swann at the meeting that part of their ongoing project is to see if parapsychology and/or psychic abilities can or should be factored into "future scenarios." Harmon explains that all was known about the ASPR goings-on, and that the attempt to expel Swann "gives you more credentials than you realize, and also makes it easier for various people."<sup>[44]</sup>

### Thursday, 8 June 1972

- o Ingo Swann goes to the home of Kirlian researcher Bill Tiller and there meets psychiatrist Shafica Karagulla.<sup>[44]</sup>

### Friday, 9 June 1972

- o OT VII Ingo Swann leaves SRI and returns to New York City.
- o John Paul Vann—who had been closely involved with Lucien Conein and Daniel Ellsberg in Vietnam contemporaneously with Green Beret Paul Preston—is killed in a bizarre helicopter crash in Vietnam.
- o G. Gordon Liddy purportedly has a private meeting with Magruder where they purportedly discuss problems with "the room monitoring device" in the DNC and the prospects of "another entry" into the Watergate. *[NOTE: There is no room monitoring device in the DNC. See Watergate first break-in.]*<sup>[44]</sup>  
<sup>[86][53]</sup>

### Monday, 12 June 1972

- o OT VII Ingo Swann agrees to return to the ASPR "for further research and experiments."<sup>[44]</sup>
- o Jeb Magruder purportedly has another private meeting with Liddy and orders Liddy to "go back into Watergate."<sup>[79][53]</sup>

*The telephone company sweep  
of Democratic National Committee headquarters in  
the Watergate finds no trace of bugs that  
Watergate burglars later will claim they had planted.*

#### Thursday, 15 June 1972

- The telephone company does a sweep of Democratic National Committee Headquarters in the Watergate. No electronic bugging devices are found. [NOTE: For full coverage, see [Watergate first break-in.](#)]<sup>[118]</sup>

#### Saturday, 17 June 1972

- Five burglars are arrested at 2:30 a.m. in Democratic National Committee headquarters in the Watergate: James McCord, Bernard Barker, Frank Sturgis, Eugenio Martinez, and Virgilio Gonzalez. All five men have a history of being employed by CIA. CIA veteran James McCord has had to tape a door latch twice to get them arrested. They have bugging equipment with them, and several of the men have in their possession amazingly traceable \$100 bills that will trace back to the White House. Bernard Barker has the phone number of E. Howard Hunt on him, indicating another connection to the White House. Almost at once the men start claiming to authorities that they had broken in weeks earlier, on 28 May 1972 (see), and were there to "fix" failures from the purported "first break-in," mainly electronic bugs. [NOTE: *But there was no first break-in, and the phone company had just days before found there were no bugs in DNC headquarters. See [Watergate first break-in](#). The amazing amount of obvious evidence on the men soon leads investigators to Liddy, Hunt, and Alfred Baldwin, who also are linked to the purported Memorial Day weekend first break-in, providing them with an alibi for their whereabouts during that weekend.*]
- CIA Director Richard Helms claims to have been "preparing for bed" (at 3:00 a.m.?) when he gets a call from CIA Chief of Security Howard Osborn informing Helms that "District police" have picked up five men in a break-in. Helms is told that James McCord is one of them, along with "four Cubans." Osborn also purportedly tells Helms that "Howard Hunt also seems to be involved in some way." Helms purportedly asks Osborn: "Is there any indication that we could be involved in this?" and is told "None whatsoever." Next, "still sitting on the edge of the bed," Helms calls Acting Director of the FBI L. Patrick Gray, who is "in a Los Angeles hotel room." Gray says that he's been informed of the break-in, but has no details. Helms tells Gray that "despite the background of the apparent perpetrators, CIA had nothing to do with the break-in."<sup>[87]</sup>



CIA Watergate Goon Platoon:  
Hunt, McCord, Barker, Baldwin, Martinez, Sturgis, Gonzalez, and Liddy.  
Director of CIA and convicted perjurer Richard Helms says: "We know the people... . But there is no CIA involvement."

#### Sunday, 18 June 1972

- Ingo Swann flies to Northfield, Minnesota to give lectures at the annual retreat of Spiritual Frontiers Fellowship (SFF).<sup>[44]</sup>

#### Thursday, 22 June 1972

- Charles Colson is interrogated by the FBI on the Watergate break-in. After interrogating Colson, the FBI is of the belief that the break-in is "a CIA thing."
- Acting FBI Director L. Patrick Gray has a meeting at about five o'clock with SA Bates, the Assistant Director in charge of the General Investigative Division of the FBI. Following the meeting, Gray places a telephone call to Richard Helms, Director of CIA, to "tell him our thought that we may be poking into a CIA operation in connection with the Watergate burglary." Helms tells Gray that Helms has been

"meeting with his men on this every day," and that "although we know the people, we cannot figure this one out. But there is no CIA involvement." Helms then meets with Gray and "asks" Gray "not to interview the two CIA men." Gray issues the order. Gray calls FBI SA Bates "immediately following that visit" from Helms, and tells Bates that "there was some CIA involvement here," that "we should proceed very gingerly and very discreetly and carry out the investigation at the Banco Internationale, and also continue to try to trace these checks through the correspondent banks, but to hold off interviewing Mr. Ogarrio." Later that evening, Gray meets with John Dean. He tells Dean that Richard Helms has said "there is no CIA involvement."<sup>[88][22]</sup>

### Friday, 23 June 1972

- 10:04 to 11:39 a.m.: In an Oval Office conversation, President Richard Nixon says "...the FBI agents who are working the case, at this point, feel that's what it is—this is CIA. ...[W]e protected Helms from one hell of a lot of things. ...This involves these Cubans, Hunt, and a lot of hanky-panky that we have nothing to do with ourselves." Ehrlichman answers that after interviewing Charles Colson the FBI "are now convinced it is a CIA thing."
- 11:06 a.m.: Acting FBI Director L. Patrick Gray has a phone conversation with John Dean. Dean tells Gray that if the FBI persists in investigating the Mexican money chain they will "be uncovering or become involved in CIA operations." Gray tells Dean that CIA Director Richard Helms told Gray the day before that "there is no CIA involvement" in the Watergate break-in. Gray also tells Dean, "if there is CIA involvement, let the CIA tell us." [NOTE: Nixon and Haldeman are still in their meeting, which goes until 11:39 a.m.]
- 2:19 p.m.: Dean calls Gray to find out if Gray has made an appointment with Deputy CIA Director Vernon Walters. Gray hasn't. Dean tells Gray that Walters will be calling Gray for an appointment and Gray should see him.
- 2:20 to 2:45 p.m.: Haldeman reports to Nixon that he and Ehrlichman [and John Dean] have met with CIA Director Helms and Deputy Director Vernon Walters. Helms has said, "We'll be very happy to be helpful," but Walters has said, "I don't know whether we can do it." Walters, though, is going to put in a call to Patrick Gray.
- 2:35 p.m. Vernon Walters meets with L. Patrick Gray. Walters says that if the FBI proceeds with the investigation into the Mexican money chain, they "would uncover CIA assets and resources" and could "interfere with some CIA covert activities." Walters then mentions to Gray "the agreement between the agencies not to uncover one another's sources," saying further that the FBI has "the five people and that the matter ought to be tapered off there."
- 2:53 p.m. After the meeting with Walters, Gray calls John Dean and tells Dean that Walters has indicated that there is "some CIA involvement," and that they will "proceed very gingerly and very discreetly and work around this until we can determine what we have ahold of."<sup>[89] [22][88]</sup>
- On the same day, an airgram is sent from the American Embassy in Copenhagen to the U.S. State Department from the Legal Attaché (LEGAT) Copenhagen titled "SUBJECT: L. RON HUBBARD FPC ." Its contents are unknown. [NOTE: The only record of this airgram is a later memorandum, dated 5 September 1972 (see), to Acting Director of FBI L. Patrick Gray, enclosing a copy of the airgram, saying it is self-explanatory.]

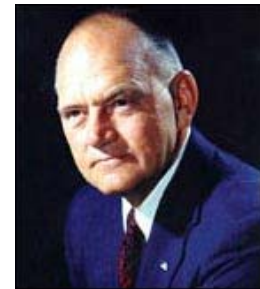

Acting FBI Director L. Patrick Gray and the CIA waltz. Gray soon will destroy crucial evidence taken from the White House safe of CIA's golden boy, E. Howard Hunt.

### Saturday, 24 June 1972

- According to Ingo Swann, he arrives in Washington, D.C. from Minnesota, ostensibly to "do book research at the Library of Congress"—but Swann says elsewhere that his trip to D.C. in 1972 was "to discuss psi phenomena with a variety of officials."<sup>[44]</sup>

### Tuesday, 27 June 1972

- Hal Puthoff contacts K. Green, Office of Strategic Intelligence (OSI) at CIA, informing Green of the results of the Varian Hall magnetometer experiment with Ingo Swann. There are also subsequent conversations between Puthoff and CIA personnel regarding this event.<sup>[19]</sup>

### Wednesday, 28 June 1972

- L. Patrick Gray gets a call from CIA Director Richard Helms, who asks Gray "not to interview active CIA men Karl Wagner and John Caswell." Gray immediately orders "that the interviews of John Caswell and Karl Wagner be held in abeyance." Caswell and Wagner's names have been found in a telephone-address notebook belonging to E. Howard Hunt.
- In the evening, John Dean turns over some of the items from the White House safe of E. Howard Hunt to Gray. Gray is provided with a large brown envelopes to carry the items away in. Dean tells Gray that included papers have "national security implications," saying they should "never see the light of day." Gray purportedly never looks at the papers, but takes them to his apartment in Washington D.C. and puts them on a closet shelf under his shirts.
- Gray has a meeting with Mark Felt and SA Bates on "the CIA ramifications."<sup>[88]</sup>

### Friday, 30 June 1972

- Scientology OT VII Hal Puthoff says in a letter to Dr. Gertrude Schmeidler in New York that he has "obtained a contract to investigate the primary perception hypothesis of Cleve Backster."<sup>[44]</sup>

### Saturday, 1 July 1972

- The classified Defense Intelligence Agency (DIA) report entitled "Controlled Offensive Behavior —USSR" is published, though its findings have been known by top personnel for months. In part, it states: "The Soviet Union is well aware of the benefits and applications of parapsychology research. The term parapsychology denotes a multi-disciplinary field consisting of the sciences of bionics, biophysics, psychophysics, psychology, physiology and neuropsychology. Many scientists, U.S. and Soviet, feel that parapsychology can be harnessed to create conditions where one can alter or manipulate the minds of others. The major impetus behind the Soviet drive to harness the possible capabilities of telepathic communication, telekinetic and bionics are said to come from the Soviet military and the KGB [Committee of State Security; Secret Police]. ...Soviet knowledge in this field is superior to that of the U.S. ...The potential applications of focusing mental influences on an enemy through hypnotic telepathy have surely occurred to the Soviets... . Control and manipulation of the human consciousness must be considered a primary goal. ...Soviet efforts in the field of psi research, sooner or later, might enable them to do some of the following: (a) Know the contents of top secret US documents, the movements of our troops and ships and the location and nature of our military installations (b) Mould the thoughts of key US military and civilian leaders at a distance (c) Cause the instant death of any US official at a distance (d) Disable, at a distance, US military equipment of all types, including spacecraft."<sup>[71]</sup>
- Yvonne Gillham Jentsch, Executive Director of Scientology's Celebrity Centre, is married to Heber Jentsch. Despite running an organization with over 200 staff members and a grueling schedule, including appearances around the U.S. and several foreign countries, she has standing orders with her office and public relations staff to locate her wherever she is if a call should come in for her from OT VII's Hal Puthoff or Ingo Swann. *[NOTE: According to staff members who contributed the information, Yvonne Jentsch had no specific knowledge at the time of Swann or Puthoff's connections with CIA or NSA, only that they both had contact with various influential people, and possibly even was of the belief that their connections were related somehow to NASA and the space race, but not to military intelligence.]*



Celebrity Centre's Yvonne (Gillham) Jentsch has standing orders to be located for any incoming calls from Puthoff or Swann

### Monday, 3 July 1972

- According to one of several conflicting accounts told by L. Patrick Gray, he burns the papers given to him by John Dean that had been taken from the safe of E. Howard Hunt in a wastebasket in his office at the FBI. *[NOTE: Gray later retracts this story, saying that he kept the papers first in his apartment, then moved them to his office, then to his home, where he burned them on or around 27 December 1972 (see).]*



- Gray has another meeting with Mark Felt, Bates, and also "Mr. Kunkel, the Special Agent in charge of the Washington Field Office" on "the CIA ramifications."<sup>[88]</sup>

### Monday, 17 July 1972

- A sum equivalent to US \$1,119,678 in Swiss francs is withdrawn in cash by Fred Hare and Vicki Polimeni from a trust fund (of questionable origin) in Switzerland and purportedly is brought aboard the Flagship *Apollo* and put into a safe. [NOTE: *Conflicting accounts in the same referenced Tax Court ruling say that the amount was over \$2 million, and also say the cash was put into a file cabinet in a strongroom instead of a safe. The same ruling also provides no accounting of what happened to the actual cash.*]<sup>[90]</sup>



Over \$1.1 million in cash never accounted for except by ledger "credit" years later, during IRS's Meade Emory restructuring of Scientology

### Wednesday, 19 July 1972

- Fred LaRue gives \$40,000 to Herbert W. Kalmbach, who takes it to New York and gives it to Anthony Ulasewicz.
- Ulasewicz delivers \$40,000 to Dorothy Hunt—wife of E. Howard Hunt—and \$8,000 to G. Gordon Liddy in unmarked envelopes left in lockers at Washington National Airport.<sup>[91]</sup>

### Wednesday, 26 July 1972

- A report is issued entitled "Report of an Out-of-Body Experiment Conducted at the American Society for Psychical Research: Participants: Dr. Carole Silfen, Janet Mitchell, Ingo Swann." The report describes an OOB experiment that suggests that a point of perception exterior to the body is able to assume "at a different location the functions performed by the visual system and the brain in the body." This is the first such experiment that verified the capability of such remote points of view.<sup>[44]</sup>



Cash to Dorothy Hunt, wife of CIA's E. Howard Hunt, and more cash to G. Gordon Liddy

### Monday, 7 August 1972

- OT VII Ingo Swann flies to San Francisco and is met by OT VII Hal Puthoff. Puthoff gives Swann an envelope containing an unspecified amount of cash, and a copy of their three-week schedule. They are to have a one-week informal period, and then a two-week formal set-up. The latter two-week segment will be attended by two CIA representatives.<sup>[44]</sup>



Unknown amount of cash delivered by NSA's Hal Puthoff to Ingo Swann

### Friday, 11 August 1972

- Ingo Swann flies to Los Angeles for the weekend with psychiatrist Shafica Karagulla and "her associate," even though he has come to SRI specifically to perform experiments in the presence of CIA personnel. No reason is given for the trip. [NOTE: *Karagulla is a neurosurgeon, and has studied under Canadian psychiatrist Wilder Penfield, infamously known for putting electrical probes into the brains of conscious subjects.*]<sup>[44]</sup>

**Monday, 14 August 1972**

- Swann is back at SRI, after his trip to Los Angeles with psychiatrist Shafica Karagulla, and is ready to begin the two-week formal experiments in the company of two representatives from CIA.<sup>[44]</sup>

**Wednesday, 23 August 1972**

- A CIA project officer contracts Hal Puthoff for a demonstration with OT VII Ingo Swann. Swann is asked to describe objects hidden out of sight by CIA personnel. The descriptions are so "startlingly accurate" that Swann purportedly is asked if he will complete the necessary forms "for a security clearance." *[NOTE: Swann is already on record as having a top secret clearance.]* He agrees to do it once he gets back to New York "where his papers are." The CIA rep suggests to CIA that the work be continued and expanded. CIA's Sidney Gottlieb reviews the data, approves another work order, and encourages the development of "a more complete research plan."<sup>[19]</sup>



Ingo Swann's weekend travelling companion Shafica Karagulla, a psychiatrist and neurosurgeon, shown here with her mentor, psychiatrist Wilder Penfield

**Saturday, 26 August 1972**

- Ingo Swann returns to New York from SRI. He prepares the application for security clearance and sends it off to Hal Puthoff.<sup>[44]</sup>

**Wednesday, 30 August 1972**

- A once-sentence letter is received by the FBI. It says: "Did you receive the printed matter that was sent to you concerning Scientology, if so please acknowledge. Thank you." *[NOTE: In the released FBI copy, the signature is blacked out. The letter is answered two days later (see 1 September 1972) by Acting FBI Director L. Patrick Gray.]*

**September 1972**

- The Scientology Flagship *Apollo* is moved to Spain for refit. The crew and officers are given the story that L. Ron Hubbard is still "living ashore" to account for his absence.

*L. Ron Hubbard has functionally disappeared, his purported whereabouts known only to a small number of people called the Special Unit'(SU).*

**Friday, 1 September 1972**

- Acting Director of FBI L. Patrick Gray responds to a once-sentence letter received by the FBI received two days earlier (see Wednesday, 30 August 1972). Gray's reply says: "Your letter was received on August 30th. With respect to your inquiry, a search of our records does not reveal any prior communication from you." *[NOTE: In the released FBI copy, the address block and the person's name is blacked out, and the letter has a note at the bottom: Correspondent is not identifiable in Bufiles.]*

**Tuesday, 5 September 1972**

- Acting Director of FBI L. Patrick Gray receives a memorandum from the Legal Attaché (LEGAT) Copenhagen (163-222) (RUC) titled "SUBJECT: L. RON HUBBARD FPC regarding an airgram sent to the State Department on 23 June 1972 (see). It says: "ReCOplet 5/23/72. Enclosed are single copies *[sic]* of an airgram dated 6/23/72, captioned "THE CHURCH OF SCIENTOLOGY IN DENMARK," from AmEmbassy, Copenhagen, to U.S. Dept. of State, which is self-explanatory." *[NOTE: Copies go to Foreign Liaison, Legat Madrid, and Copenhagen]*

**Friday, 15 September 1972**

- Hunt, Liddy, McCord and the Watergate burglars are indicted by a federal grand jury. The involvement of McCord and Liddy provide investigators with a link to the Nixon campaign. The involvement of E.

Howard Hunt provides investigators with a link to the White House.<sup>[92]</sup>

### Tuesday, 19 September 1972

- Anthony Ulasewicz flies to Washington, D.C. and delivers \$53,000 cash to Dorothy Hunt—wife of E. Howard Hunt—and \$29,000 to Fred LaRue by leaving unmarked envelopes in a locker at Washington International Airport and in the lobby of a motel near LaRue's residence.<sup>[91][93]</sup>



More cash to Dorothy Hunt, wife of CIA's E. Howard Hunt

### Saturday, 30 September 1972

- According to one of the conflicting stories he told, at the end of September Acting Director of the FBI L. Patrick Gray takes files that had been in E. Howard Hunt's White House safe to his home in Stonington, Connecticut, and puts them in a chest-of-drawers intending to burn them.<sup>[88]</sup>

### Sunday, 1 October 1972

- On a Sunday, CIA's Technical Services Division (TSD) awards OT VII Hal Puthoff a top-secret research contract to develop "remote viewing" for military espionage purposes. *[NOTE: TSD is the CIA division formerly known as Technical Services Staff. TSD is also the division running MK-ULTRA. The head of TSD is Sidney Gottlieb. The name of TSD will change a month after this contract to Office of Technical Services. Its acronym, OTS is a pun.]*<sup>[19][94]</sup>

### November 1972

- CIA Director Richard Helms calls L. Patrick Gray's "number two man," Mark Felt, stating that Helms is going to call Assistant Attorney General Peterson regarding the interview of CIA's Karl Wagner to see if it "could not be conducted...be held off."
- CIA's Sidney Gottlieb "retires."
- The name of CIA's TSD is changed to Office of Technical Services (OTS).<sup>[88][19]</sup>

### Sunday 3 December 1972

- L. Ron Hubbard purportedly "goes into hiding" in New York in the company of Green Beret Paul Preston.
- Scientology OT VIIs Hal Puthoff and Ingo Swann, now under contract with CIA, "run into" Scientology OT III Pat Price, who purportedly is selling Christmas trees at a lot in Mountain View, California—close to SRI. Puthoff is reported to "have met" Price "several years earlier" at a lecture in Los Angeles. *[NOTE: Los Angeles is the location of Scientology's Advance Organization Los Angeles (AOLA), the only place in the U.S. at the time where the OT Levels are delivered.]*<sup>[94]</sup>



OT III Pat Price

### Friday, 8 December 1972

- E. Howard Hunt's wife, Dorothy Hunt, is killed in the United Airlines airplane crash of Flight 533 as it approaches Chicago. Dorothy Hunt's purse contains \$10,585 cash, most of it in hundred dollar bills.

### Thursday, 21 December 1972

- OT VII Ingo Swann arrives to begin his CIA contract at Stanford Research Institute.
- James W. McCord writes a letter to Jack Caulfield that says in part: "If Helms goes, and if the WG (Watergate) operation is laid at the CIA's feet, where it does not belong, every tree in the forest will fall. It will be a scorched desert. The whole matter is at the precipice right now. Just pass the message that if they want it to blow, they are on exactly the right course." Caulfield replies: "I have worked with these people and I know them to be as tough-minded as you. Don't underestimate them."<sup>[94][44][95]</sup>



E. Howard Hunt's wife Dorothy is killed in a plane crash in Chicago

## 1973

### January 1973

- CIA Director Richard Helms orders that records of CIA's OTS, including records relating to MK-ULTRA, be deliberately destroyed.<sup>[96]</sup>

### Wednesday, 3 January 1973

- Daniel Ellsberg goes on trial, accused of theft and conspiracy in the disclosure of the Pentagon Papers.<sup>[97]</sup>
- On the same day, CIA's Anthony Goldin hand delivers to the Department of Justice Watergate prosecutors copies of 10 photos of E. Howard Hunt and G. Gordon Liddy taken at the office of Ellsberg psychiatrist Lewis J. Fielding, with Fielding's name on the door clearly visible. *[NOTE: See 26 August 1971, when Liddy and Hunt flew to Los Angeles to take the photos of each other.]*<sup>[93]</sup>



On the very day that Ellsberg goes on trial, the CIA hand-couriers to Watergate prosecutors CIA's own copies of photos of Liddy and Hunt in front of Fielding's office

### Thursday, 4 January 1973

- Jack Caulfield delivers to John Dean a handwritten copy of the 21 December 1972 letter Caulfield had received from James McCord: "If Helms goes, and if the WG (Watergate) operation is laid at the CIA's feet, where it does not belong, every tree in the forest will fall. It will be a scorched desert."<sup>[93]</sup>

### Thursday, 1 February 1973

- A translation of a Soviet paper, "Report from Movosibirsk: Communicaion between Cells," appears in Vol. 7, No. 2 of the Journal of Parapsychology. The report says that experiments conducted in "Special Department No. 8" indicate that cells could communicate illness, such as a virus infection, despite the fact the cells are physically separated. The tests showed that when one group of cells was contaminated with a virus, the adjacent group—although separated by quartz glass—"caught the disease."<sup>[17]</sup>

### Thursday, 1 February 1973

- OT VII Hal Puthoff and Russell Targ have meetings with "selected Agency [CIA] personnel" at CIA headquarters in Langley, Virginia, to review the results of their research contract with CIA. Several Office of Research and Development officers show interest in contributiing their own "expertise and office funding" to the research efforts. Prior to this, the contract has been with CIA's Office of Technical Services (OTS).<sup>[19]</sup>

### Wednesday, 7 February 1973

- CIA Director Richard Helms purjures himself before the Senate Foreign Relations Committee about CIA attempts to overthrow the government in Chile.<sup>[98]</sup>

### Mid February 1973

- CIA's Office of Research and Discovery (ORD) sends Project Officers to SRI to report on the remote viewing experiments of OT VIIs Hal Puthoff and Ingo Swann. ORD is considering joining CIA's Office of Technical Services in sponsoring the research on a joint program basis.<sup>[19]</sup>

**Tuesday, 6 March 1973**

- o Richard Helms testifies before the Multinational Committee, headed by Frank Church. Nothing about CIA's remote viewing program is revealed.<sup>[98]</sup>

**Saturday, 17 March 1973**

- o John Dean informs President Nixon that the Watergate Committee has learned that Justice Department prosecutors have CIA-supplied photos of E. Howard Hunt and G. Gordon Liddy taken at the office of Ellsberg psychiatrist Lewis J. Fielding. It's the first Nixon has heard anything about the Hunt/Liddy operation or of the photos. Dean says of Hunt and Liddy: "These fellows had to be some idiots." [NOTE: See 26 August 1971 and 3 January 1973]<sup>[64]</sup>
- o On or about the same day, E. Howard Hunt meets with Paul O'Brien, an attorney for the Committee to Re-elect the President. He tells O'Brien that "commitments had not been met," that he has done "seamy things for the White House," and that unless he receives \$130,000, he "might review his options."<sup>[93]</sup>



Senator Frank Church will later head 1975 investigations into U.S. intelligence agency crimes—but he never exposes CIA's remote viewing program or its genesis.

**Wednesday, 21 March 1973**

- o Fred LaRue arranges for \$75,000 in cash to be delivered to E. Howard Hunt through Hunt's attorney, William Bittman.

**April 1973**

- o According to CIA Project Officer over the SRI experiments, Ken Kress, it's about this time that Scientology OT III Pat Price starts working with OT VIIs Puthoff and Swann at SRI, and that "the remote viewing experiments in which a subject describes his impressions of remote objects or locations began in earnest." [NOTE: Hal Puthoff asserts that Pat Price came on board at SRI 1 June 1973.]<sup>[19]</sup>



\$75,000 cash is delivered to CIA's E. Howard Hunt

**Sunday, 15 April 1973**

- o Assistant Attorney General Henry Petersen supplies to Judge Matthew Byrne—the judge in the Daniel Ellsberg Pentagon Papers trial—copies of the CIA-supplied photos of E. Howard Hunt and G. Gordon Liddy in front of the office of Ellsberg's psychiatrist, Lewis Fielding.<sup>[93]</sup>
- o On the same day, John Dean tells federal prosecutors about the burglary of Dr. Lewis Fielding's office in Los Angeles, engineered by E. Howard Hunt.<sup>[98]</sup>
- o OT VII Ingo Swann comes up with the name "coordinate remote viewing" instead of just "remote viewing."<sup>[94]</sup>



John Dean spills the beans on the "break-in" at psychiatrist Lewis J. Fielding's office. All charges soon will be dropped against Ellsberg.

**Monday, 16 April 1973**

- o E. Howard Hunt confirms what John Dean has told federal prosecutors the previous day about the burglary of psychiatrist Lewis Fielding's office in Los Angeles.<sup>[98]</sup>

**Friday, 20 April 1973**

- o CIA's Office of Research and Development decides to become involved in the remote viewing research, requests an increase in the scope of the effort, and transfers funds to CIA's Office of Technical Services (OTS): "C/TSD; Memorandum for Assistant Deputy Director for Operations; Subject: Request for Approval of Contract; 20 April 1973 (SECRET)."<sup>[19]</sup>

**Late April 1973**

- o OT VII Ingo Swann's "coordinate remote viewing" experiments are getting more accurate and promising results, prompting Hal Puthoff and Russell Targ to continue the experiments.<sup>[94]</sup>

**Early May 1973**

- CIA Project Officer Ken Kress is told not to increase the scope of the SRI remote viewing research because it's "too sensitive": CIA's Office of Technical Services (OTS) is being investigated for involvement in the Watergate affair.<sup>[19]</sup>
- Director of Central Intelligence Dr. James Schlesinger issues a memorandum to all CIA employees requesting the reporting of any activities that may have been illegal and improper: CIA operations are being investigated in connection with Watergate.<sup>[19]</sup>

**Friday, 11 May 1973**

- Because of CIA-supplied photos of G. Gordon Liddy and E. Howard Hunt at the office of Daniel Ellsberg psychiatrist Lewis Fielding and the subsequent revelations, all charges against Daniel Ellsberg for leaking the Pentagon Papers are dropped and his case dismissed on the grounds of "government misconduct."<sup>[99]</sup>

*Daniel Ellsberg is cleared of  
all charges because of CIA-supplied photos—that had been  
taken with a CIA camera and developed by CIA—of Liddy and  
Hunt in CIA garb in front of psychiatrist  
Lewis Fielding's office.*

**Monday, 21 May 1973**

- A twenty-six-page preliminary summary of the reports from CIA employees regarding questionable activities is sent to DCI William Colby under the title "Potential Flap Activities." The full report, completed later, comes to 693 pages in all, one for each "abuse," and it quickly acquires the *nom de scandale* of "the Family Jewels." It includes reports on CIA's involvement in assassination plots.<sup>[98]</sup>

**Tuesday, 29 May 1973**

- CIA analyst Richard Kennet gives a set of coordinates he's gotten from a CIA colleague to Hal Puthoff at SRI as a "rigorous scientific experiment," coordinates that Kennet himself doesn't know anything about.<sup>[94]</sup>

**Early June 1973**

- OT VII Ingo Swann and OT III Pat Price do remote viewing sessions on the coordinates given to Hal Puthoff by CIA's Richard Kennet. Their results are similar, both sketching something that resembles some sort of military installation. Price's report is detailed, including even code names on file folders on desks and inside file cabinets, and names of military personnel. Puthoff sends the information off to CIA's Richard Kennet.<sup>[94]</sup>

**Friday, 8 June 1973**

- Richard Kennett shows Pat Price's and Ingo Swann's "coordinate remote viewiing" results to his CIA colleague, Bill O'Donnell, who had provided Kennett the coordinates in question to begin with [*see timeline entry for 29 May 1973*]. O'Donnell it isn't even close; he had given Kennett map coordinates for his summer cabin in the woods.<sup>[94]</sup>

**Sunday, 10 June 1973**

- Richard Kennett takes his wife and children on a "drive into the countryside" in the Blue Ridge Mountains to check out Bill O'Donnell's accounting of the coordinates Pat Price and Ingo Swann had remotely viewed. "A few miles from his friend's cabin," Kennett discovers a dirt road with a government "No Trespassing" sign, and some satellite antennas in the background—"obviously some kind of secret installation." It seems to match many of the descriptions provided by Price and Swann.<sup>[94]</sup>

**Monday, 11 June 1973**

- Richard Kennett looks up "an official who he thought might know about" the strange secret base he and his wife and kids have discovered on their weekend drive to West Virginia, and gives the unnamed official Pat Price's and Ingo Swann's descriptions from their "coordinate remote viewing" sessions.<sup>[94]</sup>

### Wednesday, 13 June 1973

- CIA's Richard Kennett finds himself at the center of an intense and hostile security investigation over the "coordinate remote viewing" descriptions of Scientology OTs Pat Price and Ingo Swann of the secret installation in West Virginia. The investigation soon extends to Price, Swann, and OT VII Hal Puthoff at SRI. The facility, ostensibly a U.S. Navy communications base, is actually a highly sensitive NSA installation.<sup>[94]</sup>
- The NSA's David Young—who has been granted immunity by Watergate prosecutors—turns over to them a one-page memo revealing a 1971 plan for G. Gordon Liddy and E. Howard Hunt to arrange a break-in at the office of Ellsberg psychiatrist Lewis J. Fielding.<sup>[100]</sup>

### Late June 1973

- Hal Puthoff and Russell Targ brief senior CIA officials at CIA Headquarters in Langley, Virginia on their remote viewing research. The officials include Office of Technical Services (OTS) chief John McMahon and Deputy Director for Science and Technology Carl Duckett.<sup>[94]</sup>

### July 1973

- Hal Puthoff and Ingo Swann travel to Prague for the First International Congress on Psychotronic Research. Word comes from CIA that the leader of the Soviet group is a KGB officer. At the same conference is CIA's Cleve Backster.<sup>[94][101]</sup>

### August 1973

- OT III Pat Price is given coordinates supplied by CIA's Ken Kress for coordinate remote viewing experiments. Price identifies a Soviet military research facility at the southern edge of the Semipalatinsk nuclear test area in the Kazakh Republic. The accuracy of Price's reports about the place become an important factor in future funding of the remote viewing research of Puthoff, Targ, et. al.<sup>[94]</sup>
- CIA officials discuss parapsychology with "several members" of DIA (Defense Intelligence Agency). The "DIA people" are interested in the Soviet activities in this area, and express considerable interest in the CIA/SRI experiments.<sup>[19]</sup>
- Ingo Swann's contract at SRI ends. He returns to New York. *[NOTE: Later timeline entries indicate that Ingo Swann has been training CIA 'in-house' remote viewers.]*<sup>[94]</sup>

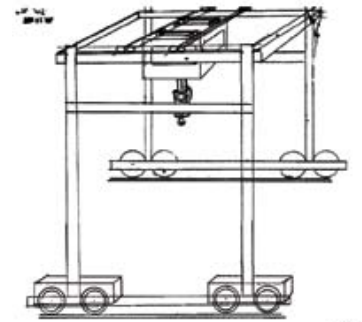

TOP: OT III Pat Price remote viewing sketch of Soviet gantry at Semipalatinsk.  
BOTTOM: CIA illustration of gantry made from satellite photos.

### October 1973

- Ingo Swann is flying from New York to Los Angeles every weekend to receive Scientology services at Celebrity Centre from Jim Fiducia. Swann has completed a service called "Grade IV Expanded." He writes a Scientology "success story" that says in part: "The precision of Ron's (L. Ron Hubbard's) auditing technology...is such a great contribution to history and humanity that words are not enough. Utilizing the technology is what to do 'in this point in time.'<sup>[102]</sup>

### Early November 1973

- William Colby has become Director of Central Intelligence (DCI).<sup>[19]</sup>

*Ingo Swann, developing remote viewing for CIA, says: The precision of [L. Ron Hubbard's] technology is such a great contribution to history and humanity that... utilizing the technology is what to do in this point in time."*

### Friday, 9 November 1973

- o CIA's K. Green issues a report on the 1 June 1973 [see] coordinate remote viewing experiment with Ingo Swann and Pat Price that had targetted a secret NSA installation in West Virginia: "K. Green; LSD/OSI; Memorandum for the Record; Subject: Verification of Remote Viewing Experiments at Stanford Research Institute; 9 November 1973. (SECRET)." The "new directors" of CIA's Office of Technical Services and Office of Research and Development are favorably impressed.<sup>[19]</sup>

### Late November 1973

- o Based on the favorable impression made by the 9 November 1973 "Verification of Remote Viewing" report, a CIA Statement of Work is outlined, and the SRI team (Puthoff, Targ, et al.) is asked to propose another program.<sup>[19]</sup>

## 1974

### January 1974

- o NSA's Hal Puthoff, a Scientology OT VII contracted to CIA, has completed "Dianetic Auditing" at Scientology's Celebrity Centre in Los Angeles. His "Success Story" soon appears in *Celebrity* magazine saying he has "a feeling of absolute fearlessness." He has represented himself to the Scientologists as merely a "Professor, Stanford Research Institute."
- o Somehow the Department of Justice and FBI have upper level, confidential Scientology (OT) materials in their files.<sup>[103]</sup>

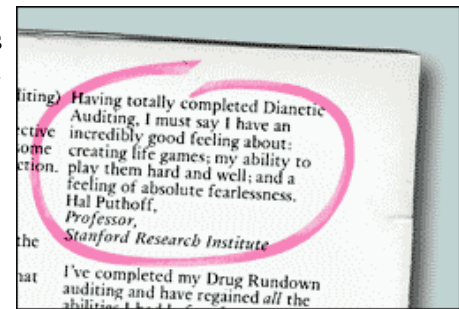

NSA's Hal Puthoff doing Scientology services at Celebrity Centre as a "professor." (Scans contributed, from *Celebrity* magazine *Minor Issue 9*, circa February 1974.)

### Friday, 1 February 1974

- o A new CIA program, jointly funded by Office of Research and Development (ORD) and Office of Technical Services (OTS) is begun at SRI. Kenneth Kress is the author Project Officer of the program. The project is to proceed on the premise that the phenomena associated with remote viewing exist; the objective is to develop and utilize them. The program is referenced by a cite: "Office of Technical Services Contract, FAN 4125-4099; Office of Research and Development Contract, FAN 4162-8103; 1 February 1974 (CONFIDENTIAL)."<sup>[19]</sup>

### Tuesday, 5 February 1974

- o Hal Puthoff is contacted by the Berkely police, requesting psychic assistance in the investigation into the disappearance of Patty Hearst. That afternoon, Puthoff and Pat Price meet with the police at Patty Hearst's apartment, where Price says it is not a kidnapping for money, but for political reasons. They go down to the police station, where Price picks out three photos from mug books, and associates the word "Lobo" (spanish for "wolf") with one of the men he has selected. (All three men Price picked are later confirmed to be members of the "Symbionese Liberation Army," which has kidnapped Hearst. The man with the "lobo" association turns out to be William Wolfe, a.k.a. "Willie the Wolf.")<sup>[94]</sup>



Pat Price, a Scientology OT III involved in the secret CIA remote viewing program, is called in to help on the Patty Hearst kidnapping

### Saturday, 17 August 1974

- o Ingo Swann gives a lecture to about 250 Scientologists at Laurel Springs Ranch in Santa Barbara, California: "What has Scientology got to do with Psychic Research?" Its topics include, "What is a Spirit? Its Potentials, and How Scientology provides a workable way for anyone to know the answers for himself." Swann has flown in from New York for the lecture—where Swann



secretly has been training CIA personnel in Scientology-based remote viewing.<sup>[104]</sup>

### Tuesday, 20 August 1974

- A secret internal CIA report is issued regarding OT III Pat Price's August 1973 *[see]* remote viewing of a Soviet Research and Development facility: "W. T. Strand; C/ESO/IAS; Memorandum for Director, Officer of Technical Service; Subject: Evaluation of Data on Semipalatinsk Unidentified R&D Facility No. 3, USSR; 20 August 1974 (SECRET)."<sup>[19]</sup>

### Thursday, 29 August 1974

- Scientology legal has filed a Freedom of Information Act (FOIA) request to the U.S. Treasury Department that becomes civil case No. 76-1719, CSV v. Secretary of the Treasury, in U.S. District Court for the District of Columbia. *[NOTE: The case will be considerably expanded, entailing hundreds of documents, and including the Secret Service. Although some documents are ultimately released to the Scientologists, many are withheld under the penumbra of agency's executive privilege which exempts from FOIA the decision-making processes of government agencies and under protected inter-agency or intra-agency memorandums or letters.]*

### Early October 1974

- Ingo Swann returns to SRI as a "consultant." *[NOTE: Later timeline entries indicate that Ingo Swann has been training CIA in-house "remote viewers.]*<sup>[94]</sup>

### Friday, 18 October 1974

- A paper by OT VII Hal Puthoff and Russell Targ appears in *Nature* magazine: "Information Transfer Under Conditions of Sensory Shielding."<sup>[94]</sup>

### Thursday, 12 December 1974

- A CIA report: "CI/Staff/DDO; Memorandum for the Record; Subject: SRI Experiment; 12 December 1974 (SECRET)."<sup>[19]</sup>

### Monday, 16 December 1974

- The Founding Church of Scientology, Washington D.C. (FCDC) seeks access through FOIA to all records maintained by the National Security Agency (NSA) on FCDC and Scientology, as well as any records reflecting dissemination of information to other domestic agencies or foreign governments. *[NOTE: The action is soon expanded to include all references to other specific Scientology organizations and to L. Ron Hubbard. NSA claims in response that it has no records related to Scientology or Hubbard. That will turn out to be a lie, but the documents ultimately will be withheld on grounds of national security and confidentiality specifically imparted by other statutes.]*

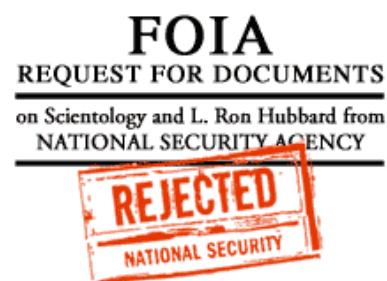

NSA initially lies and says they have no documents on Scientology or Hubbard. NSA's Hal Puthoff, a Scientology OT VII, is running the secret remote viewing program for CIA.

### Thursday, 19 December 1974

- The Church of Scientology of California (CSC) files FOIA requests for 145 documents from the U.S. Treasury, the U.S. Secret Service, the Secretary of the Treasury, and the Director of Secret Service pertaining to Scientology and Scientologists and to L. Ron Hubbard.

### Sunday, 22 December 1974

- The New York Times publishes an article by Seymour Hersh regarding the secret Operation Chaos. Gerald Ford is President. DCI William Colby phones Ford, who is vacationing in Vail, Colorado, and tells him that Hersh has distorted the record, and that the "excesses" of CIA had all ended in 1973—following Helms's departure.<sup>[98]</sup>

## 1975

## January 1975

- Secret internal CIA reports are issued:
  1. "AC/SE/DDO; Memorandum for C/D&E; Subject: Perceptual Augmentation Testing; 14 January 1975 (SECRET)"
  2. "Chief/Division D/DDO; Memorandum for C/D&E; Subject: Perceptual Augmentation Techniques; 24 January 1975
  3. "J. A. Ball; "An Overview of Extrasensory Perception"; Report to CIA, 27 January 1975.
  4. "C/Libya/EL/NE/DDO; Memorandum for OTS/CB; Subject: Libyan Desk Requirement for Psychic Experiments Relating to Libya; 31 January 1975 (SECRET)"
  5. "C/EA/DDO; Memorandum for Director of Technical Service; Subject: Exploration of Operational Potential of 'Paranormals'; 5 February 1975 (SECRET)"<sup>[19]</sup>
- An internal CIA report is issued regarding the results of remote viewing experiments performed by CIA "insiders"—all members of CIA's Office of Technical Services (OTS): "OTS/SDB; Notes on Interviews with F. P., E. L., C. J., K. G., and V. C., January 1975 (SECRET)." *[NOTE: This is the first confirmation that CIA has their own in-house personnel as remote viewers. Later timeline entries indicate that Ingo Swann has been training CIA in-house remote viewers.]*<sup>[19]</sup>
- Around this time, Ingo Swann purportedly leaves Scientology: "I exited Scientology of my free will in 1975 and under reasonably amicable circumstances." *[NOTE: Unfortunately, Swann's claim is simply a lie. In August 1977 (see) he is one of the speakers listed for Scientology's International Prayer Day, and in April 1979 (see) he is listed in a Scientology publication as having completed a service called New Era Dianetics for OTs.]*
- Around the same time, FCDC expands its FOIA action against NSA to include all references to L. Ron Hubbard, founder of Scientology.
- Around the same time, Meade Emory is appointed as Assistant to the Commissioner of IRS, Donald C. Alexander. *[NOTE: During Emory's tenure, a clerk typist named Gerald Wolfe will be hired at IRS despite a hiring freeze. Wolfe will begin feeding stolen documents to Scientology's Guardian Office, which later will be raided by FBI. The Guardian Office principals, including Mary Sue Hubbard, will be sent to jail. In the aftermath, Meade Emory engineers L. Ron Hubbard's probate, restructures all of Scientology, and becomes one of the Founders of Church of Spiritual Technology, the ultimate beneficiary of L. Ron Hubbard's estate.]*



**Meade Emory becomes Assistant to Commissioner of IRS. By 1982, Emory will restructure all of Scientology, putting it in the control of three lawyers who are not Scientologists**

## Friday, 14 February 1975

- The NSA replies to FCDC's FOIA action that it has not established any file pertaining either to FCDC or L. Ron Hubbard, and that it has transmitted no information regarding either to any domestic agencies or foreign governments. *[This proves later to be a bald faced NSA lie.]*

**Thursday, 27 February 1975**

- CBS correspondent Daniel Schorr, in a meeting with CIA Director William Colby, asks Colby point blank, "Has the CIA ever killed anybody in this country?" Colby responds: "Not in this country." Schorr is stunned at Colby's oblique admission, but Colby will not answer further questions about it, saying only that assassinations had been "formally prohibited in 1973." [NOTE: See 1972.]<sup>[98]</sup>

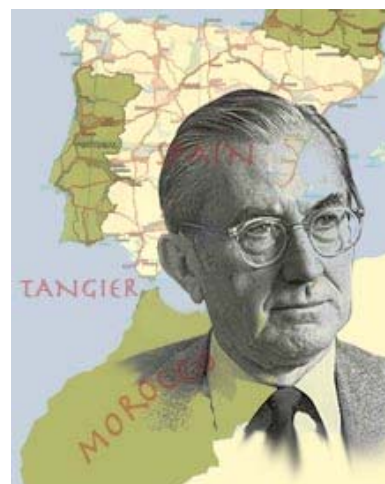

CIA's William Colby on CIA assassinations:  
"Not in this country."

**Early-mid March 1975**

- FCDC expands its FOIA action against NSA, naming other Scientology organizations that NSA is suspected of having documents on. NSA again denies possession of any of the data sought. [NOTE: This, too, proves later to be a lie. As has been thoroughly covered, OT VII Hal Puthoff, running the secret CIA remote viewing program, is NSA.]
- Around the same time, all CIA funding of remote viewing and paranormal research purportedly comes to a sudden halt. "To achieve better security," the "operations-oriented testing" of remote viewing with Scientology OTs Hal Puthoff and Ingo Swann purportedly is stopped.<sup>[19]</sup>
- Around the same time, CIA "personal services" contract with Scientology OT III Pat Price is started.<sup>[19]</sup>
- Pat Price departs SRI. He claims he is going to "work for a coal company" in Huntington, West Virginia, and intends to return in a year. He is working directly for CIA as a contractor.<sup>[94]</sup>

**Thursday, 12 June 1975**

- Two internal CIA reports are issued regarding a device being used at SRI in remote viewing research:
  1. "L. W. Rook; LSR/ORD; Memorandum for OTS/CB; Subject: Evidence for Non-Randomness of Four-State Electronic Random Stimulus Generator; 12 June 1975 (CONFIDENTIAL)."
  2. "S. L. Cianci; LSR/ORD; Memorandum for OTS/CB; Subject: Response to Requested Critique, SRI Random Stimulus Generator Results; 12 June 1975 (CONFIDENTIAL)."<sup>[19]</sup>

**Monday, 23 June 1975**

- In the course of FOIA proceedings against the Department of State and the Central Intelligence Agency (CIA), FCDC learns that NSA has at least sixteen documents concerning Scientology, FCDC and related organizations despite NSA's claims for months that they had no such documents. Suddenly, confronted with details extracted by FCDC from the CIA, the NSA "succeeds" in locating fifteen of those items "in warehouse storage," and obtains a copy of the sixteenth from CIA. Then NSA takes legal action to prevent release of the materials on grounds of national security.

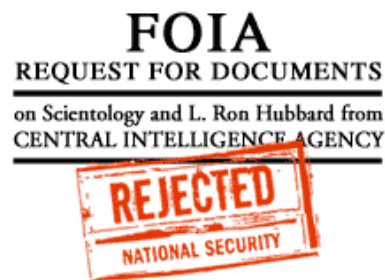

Scientology FOIA actions against CIA expose NSA's lie about having no relevant documents. Both FOIA actions are ultimately thrown out by courts on grounds of "national security."

**Friday, 11 July 1975**

- OT III Pat Price, on a "personal services contract" with CIA, is given a "second requirements list" for a Libyan installation Price had earlier identified with remote viewing as a guerilla training site. Price dies "a few days later."<sup>[19]</sup>

**Tuesday, 15 July 1975**

- OT III Pat Price leaves from Huntington, West Virginia on a several-week trip west. He first stops and has dinner in Washington, D.C.<sup>[94]</sup>

**Wednesday, 16 July 1975**

- OT III Pat Price arrives in Las Vegas, en route first to SRI, then to Los Angeles. In Vegas, Price is met by an old friend named Bill Alvarez and his wife, Judy. The three check into the Stardust Hotel and go into the restaurant for dinner. Price begins to complain that he doesn't feel well, and tells the Alvarezes that someone "had seemed to slip something into his coffee" at dinner in Washington the night before. Price

soon feels so bad that he goes up to his room to lie down. He feels even worse and calls the Alvarezes. They come to his room and find him on the bed apparently in cardiac arrest. Bill Alvarez calls paramedics, who try without success to resuscitate Price. He is declared dead in the local hospital's emergency room. A mysterious "friend" of Price's turns up at the emergency room with "a briefcase full of his medical records," which, along with the statements of the emergency room's physician, are enough to waive an autopsy—which would normally be performed on an out-of-towner who had died outside the hospital.<sup>[94]</sup>

#### Tuesday, 9 September 1975

- Pursuant to FCDC's FOIA requests, Department of Defense and Department of the Army have released a number of documents in their entirety, released only edited versions of others, and refused to release any portion of certain documents. Dissatisfied, the Church resorts to legal action to compel disclosure. On September 9, 1975, the Church files a complaint seeking an injunction against withholding of records: Church of Scientology v. United States Department of the Army, No. CV-75-3056-F. Named as co-defendants in the action are Secretary of the Army, the U. S. Intelligence Agency and Assistant Chief of Staff for Army Intelligence. [NOTE: This FOIA case will be lost mainly on grounds of national security.]

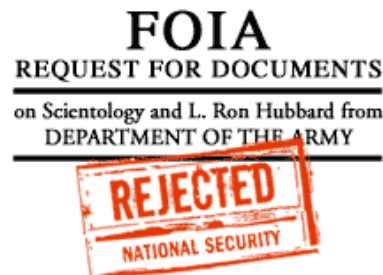

Although relevant records are still classified, there can be little doubt that the remote viewing program is going directly to benefit the Army, since the entire purpose was for military intelligence. This case, too, will be thrown out on grounds of "national security."

#### Wednesday, 8 October 1975

- A CIA report is done regarding experiments being done at SRI: "G. Burow; OJCS/AD/BD; Memorandum for Dr. Kress; Subject: Analysis of the Subject-Machine Relationship; 8 October 1975 (CONFIDENTIAL)."<sup>[19]</sup>
- A CIA report is issued that's somehow related to the "requirements list" for a Libyan remote viewing target that was allegedly passed to Pat Price just days before he died: "DDO/NE; Memorandum for OTS/BAB; Subject: Experimental Collection Activity Relating to Libya; 8 October 1975 (SECRET)."<sup>[19]</sup>

#### Thursday, 4 December 1975

- In addition to it 9 September FOIA suit, Scientology's FCDC files a complaint seeking an injunction against withholding of records in Church of Scientology v. United States Department of Defense, No. CV-75-4072-F. Named as co-defendants in the action are Office of the Secretary of Defense, Secretary of the Department of Defense, United States Department of the Navy, Secretary of the Navy, Naval Intelligence Command, and Director of Naval Intelligence. [NOTE: This FOIA case, too, will be lost mainly on grounds of national security.]
- On the same day, an internal CIA report is issued on a Pat Price remote viewing of a Soviet Research and Development facility is issued: "D. Stillman; Los Alamos Scientific Laboratory; "An Analysis of a Remote Viewing Experiment of URDF-3"; 4 December 1975 (CONFIDENTIAL)."<sup>[19]</sup>

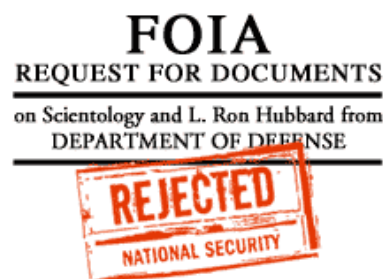

The Defense Department also will be protected by U.S. Courts from releasing the documents on the grounds of "national security."

## 1976

#### Wednesday, 14 January 1976

- The AiResearch Manufacturing Company completes a report to CIA indicating that further developments in long-distance telepathy are continuing in the Soviet Union.<sup>[17]</sup>

#### Friday, 30 January 1976

- George H.W. Bush becomes Director of CIA.

**March 1976**

- OT VII Hal Puthoff and Russel Targ publish an article: "A Perceptual Channel for Information Transfer Over Kilometer Distances; Historical Perspective and Recent Research" *Proceedings of the IEEE LXIV* March 1976 Number 3, 329-354.<sup>[19]</sup>

**Monday, 16 August 1976**

- Scientology's FCDC files suit in District Court to compel NSA to conduct a renewed search of its files, and to enjoin NSA from any withholding of the materials. FCDC serves numerous interrogatories on NSA inquiring into its efforts to locate the records, its classification of documents, and its correspondence with CIA with respect to the NSA items that had been uncovered in FOIA actions against CIA. NSA declines to supply more than minimal information in answer to the interrogatories. *[NOTE: All Scientology FOIA actions are being handled by Scientology's Guardian Office, regardless of the specific Scientology organization filing the requests or suits.]*



Scientology's Guardian Office has authority over all Scientology legal actions, and is directing the FOIA cases against NSA, CIA, and other U.S. agencies and departments

**Tuesday, 24 August 1976**

- Opening Day of Scientology's "First International Conference for World Peace and Social Reform and Human Rights Prayer Day" at the Anaheim Convention Center in Anaheim, California. Ingo Swann has been promoted to be one of the many speakers at the event. Another one of the listed speakers is an unnamed "former Executive Assistant to the Deputy Director of the CIA." Also featured at the event are the Hubbard children—Diana, Suzette, Quentin, and Arthur—as well as Celebrity Centre director Yvonne (Gillham) Jentzsch.<sup>[3][105]</sup>

**Thursday, 28 October 1976**

- Quentin Hubbard, son of L. Ron Hubbard, is found in a coma in a car parked near McCarran airport in Las Vegas, Nevada without any identification on him. He never comes out of the coma and dies just over two weeks later, still unidentified. Clark County Medical Examiner Sheldon Green determines the cause of death to be carbon monoxide poisoning, but says the "mode and manner" of death are unknown. Although ultimately able to identify Quentin through automobile records, the effort isn't made until after he has died. Autopsy reveals evidence of staph, and an angiogram had revealed a "possible cerebral abcess." *[NOTE: A little over a year later, Yvonne (Gillham) Jentzsch will die mysteriously, first diagnosed as having a staph infection, but with cause of death later being attributed to a brain tumor.]*



L-to-R: Diana, Quentin, Suzette, and Arthur Hubbard at the Human Rights Prayer Day event in Los Angeles just a little over two months before Quentin is found in Las Vegas in a coma from which he never recovers

**November 1976**

- George H. W. Bush (Sr.) is Director of Central Intelligence. He learns that Soviet officials have been visiting and questioning Hal Puthoff and Russell Targ at SRI. Bush requests and receives a briefing on CIA's investigations into parapsychology. Before there is any official response from Bush, he leaves CIA.<sup>[19]</sup>

**1977****Monday, 31 January 1977**

- Scientology's FCDC files a suit against the Director of CIA and others, No. 77-0175. The suit alleges that Scientology has been the subject of a government-wide conspiracy to destroy a religion. It claims that the church's constitutional and statutory rights have been violated in that the government agencies have improperly maintained and disseminated information; harassed, observed, and infiltrated the organization; "blacklisted" members; and subjected the organizations to discriminatory tax audits. Defendants include the Director of the FBI, the Attorney General of the United States, the Director of the CIA, the Secretary of the Treasury, the Chief of the National Central Bureau of the International Criminal Police Organization (INTERPOL); the Director of NSA; the Secretary of the Army; and the Postmaster General of the Postal Service. The United States is also named as a defendant. *[NOTE: George H.W. Bush leaves as Director of CIA at almost the same time this case is filed. This suit, as all the other Scientology FOIA cases, is being handled by Scientology's Guardian Office, run by Mary Sue Hubbard. Just over six months after this suit is filed, the Guardian Office is raided by the FBI and all of its senior members are charged with stealing IRS and other government agency documents. They will be sentenced to jail terms. In the aftermath, IRS's Meade Emory will tear down the entire Scientology corporate structure and rebuild it, but Meade Emory's work will be in secret, and the restructuring will be publically attributed to L. Ron Hubbard, whose whereabouts are unknown the entire time.]*

#### April 1977

- The CIA's Office of Scientific Investigation completes a study about Soviet military and KGB applied parapsychology: "T. Hamilton; LSD/OSI; "Soviet and East European Parapsychology Research," SI 77-10012, April 1977 (SECRET/NOFORN)."<sup>[19]</sup>

#### Thursday, 2 June 1977

- The United States District Court for the Central District of California issues a Summary Judgement for the U.S. in the Scientology FOIA action No. CV-75-3056-F (CSC v. Army), granting the Department of the Army the right withhold documents and portions of documents pertaining to Scientology and its founder, L. Ron Hubbard. Grounds are "national security."
- On the same day, the United States District Court for the Central District of California issues a Summary Judgement for the U.S. in the Scientology FOIA action No. CV-75-4072-F (CSC v. Defense), granting the Department of Defense the right withhold documents and portions of documents pertaining to Scientology and its founder, L. Ron Hubbard. Grounds are "national security." *[NOTE: The Guardian Office still has FOIA actions outstanding against NSA, CIA, et al. Just over a month after this ruling, though, the Guardian Office will be raided by the FBI.]*

#### Friday, 8 July 1977

- The Federal Bureau of Investigation, using chain-saws and axes, mounts three simultaneous early-morning raids of Scientology Guardian Office facilities on opposite coasts: the Cedars complex and Fifield Manor in California, and the Washington, D.C. (FCDC) office 06:00 hours Pacific time. At the time of these raids, the Guardian Office is managing Freedom of Information Act (FOIA) suits against the Directors of CIA and the FBI, plus the CIA itself, the National Security Agency (NSA), the Department of Defense, Army Intelligence, Naval Intelligence, the Treasury Department (including IRS), INTERPOL, and the Attorney General of the United States. *[NOTE: The senior Guardian Office (GO) personnel will be sent to jail as a result of the raid, with the GO soon being disestablished altogether. Control over the other Scientology FOIA actions is severely compromised, and all are ultimately lost on grounds of national security.'Soon after, Meade Emory begins restructuring Scientology to have the ownership and control of the materials put under three non-Scientologist tax*



The FBI launches simultaneous early-morning raids on three Guardian Office locations: two in Los Angeles, one in Washington, D.C.

and probate attorneys. See 28 May 1982.]

- The CIA has appropriated Scientology Advanced Technology via the use of Scientology OTs who have developed "remote-viewing" techniques, and who have trained CIA personnel. The CIA has a super-secret remote-viewing installation now set up, which has been joined to the U.S. Army Intelligence Agency's merger with the Army Security Agency to form the all-in-one "Intelligence and Security Command" (INSCOM). Under INSCOM, a major and super-secret remote-viewing program is being established at Fort Meade. It has been described thus: "The...researchers, in rivalry with their Soviet counterparts, were attempting nothing less than the development of the perfect spies, human beings who, undetectably and at almost zero cost, could spy upon the most remote, sensitive, and heavily guarded locations." The program has gone under the code name SCANATE (for "SCAN by coordiNATE"), but soon will become Project GRILLFLAME, and evolve into Project STAR GATE. The CIA, NSA, and the Defense Intelligence agencies are all fighting the Guardian Office FOIA actions, largely on the grounds of "national security" (although other justifications are thrown in for window dressing). Even Congress, other than the oversight committee, does not know about these secret intelligence projects utilizing Scientology and Scientologists.

### Tuesday, 9 August 1977

- CIA Director Stansfield Turner reveals publicly, but obliquely, that CIA has had "operational interest in parapsychology." <sup>[106] [19]</sup>

### Friday, 4 November 1977

- Former CIA Director Richard Helms appears in federal court in Washington, D.C. for sentencing on perjury before a Congressional Committee. Judge Barrington D. Parker reads Helm a stern lecture and announces the sentence: a \$2000 fine and two years in jail—then suspends the sentence.<sup>[98]</sup>

## 1978

### Tuesday, 17 January 1978

- Yvonne (Gillham) Jentzsch, who founded Celebrity Centre and has been closely connected to Hal Puthoff and Ingo Swann, dies at the Scientology Flag Land Base in Florida. There is a good deal of mystery surrounding her death. She had gone to Flag to be handled for a staph infection that had started in a leg, but then her death is reported as having been from a brain tumor.



Founder of Celebrity Centre Yvonne (Gillham) Jentzsch dies under mysterious circumstances with similarities to medical findings in Quentin Hubbard's untimely death  
(Portrait by William Shirley)

### May 1978

- The SRI remote-viewing team is called upon to rapidly try and locate, with remote viewing, a downed Soviet Tupolev-22 bomber that had been configured for gathering electronic and photographic intelligence, and had gone down in the jungles the day before somewhere in Zaire. The task is given to two remote-viewers: Gary Langford at SRI (under Scientology OT VII Hal Puthoff), and a woman named Frances Bryan at Wright-Patterson Air Force Base. Both produce sketches of a river, which get matched to maps of the general area where the plane is thought to have been. A cabled summary of their results goes to the CIA station chief in Kinshasa, but the co-ordinates are over 70 miles from where the local CIA team believe the plane has gone down. The wreckage of the plane is soon found less than three miles from where the remote-viewers had pin-pointed it. CIA Director Stansfield Turner briefs President Jimmy Carter on the successful operation and recovery. [NOTE: Seventeen years later, Carter briefly describes this incident during a speech at a college, even though the entire program is still top secret at the time.]<sup>[94]</sup>

### Tuesday, 31 October 1978

- Two senior scientists from the Soviet Ministry of Defense—Jan I. Koltunov and Nikolai A. Nosov—

become members of the Moscow Bio-Electronics Laboratory, which is doing research in telepathy.<sup>[17]</sup>

#### Thursday, 7 December 1978

- The KGB restructures the Moscow Laboratory for Bio-Electronics' "Rules for Admittance to Membership in the Central Public Laboratory for Bio-Electronics," creating stringent security requirements.<sup>[17]</sup>

## 1979

#### January 1979

- Funding and tasking of remote viewing are being coordinated by the DIA, and the separate elements of the project are going by the collective code name GRILL FLAME. Integration of the project provides political cover for other agencies that might have been embarrassed to fund psychic spying directly. Atop this cover is Jack Vorona, who heads the DIA's Scientific and Technical Intelligence Directorate (known as "DT") as one of the Pentagon's top scientists. Funding for the SRI branch of the remote viewing operation alone, where Scientology OTs Hal Puthoff and Ingo Swann are operating, is estimated to run close to \$1 million annually.<sup>[94]</sup>

#### Monday, 5 March 1979

- OT VII Hal Puthoff receives a call from the Jet Propulsion Laboratory (JPL) at La Canada, California. Raw data is coming in from the space probe Voyager 1, which is approaching Jupiter. JPL scientists have been completely surprised to discover that there is a ring around Jupiter. Puthoff's remote-viewing associate at SRI, OT VII Ingo Swann, had, on 27 April 1973 [see]—nearly six years earlier—remote-viewed Jupiter and had described and sketched just such a ring around the planet. Swann's results regarding Jupiter had been laughed off at the time.<sup>[107]</sup>

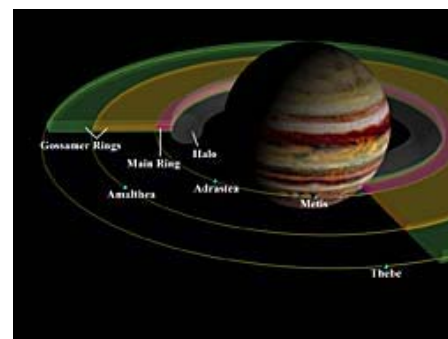

Jupiter is discovered to have rings

#### April 1979

- OT VII Ingo Swann is listed in Scientology's *Source* magazine issue 20 as having completed New Era Dianetics for OTs.

*Despite strict Scientology policies against it, Ingo Swann, while working for the CIA, is still doing upper-level Scientology services—even though Swann later claims he left Scientology in 1975."*

#### Sunday, 15 April 1979

- OT VII Hal Puthoff issues an SRI Internal Report, "Feasibility Study on the Vulnerability of the MPS System to RV [Remote Viewing] Detection Techniques." [NOTE: MPS = Mapping, Chart, and Graphics Production System of the National Imagery and Mapping Agency (NIMA)]<sup>[108]</sup>

#### July 1979

- Hella Hammid, a remote viewer working in the CIA-initiated program at SRI under OT VIIs Hal Puthoff and Ingo Swann, successfully describes microscopic picture targets as small as one millimeter square in an experimental series, and also correctly identifies a silver pin and a spool of thread inside an aluminum film can.<sup>[109][110]</sup>

#### September 1979

- The GRILL FLAME remote viewing headquarters at Fort Meade, Maryland is an outgrowth of the Scientology-based CIA-initiated remote viewing studies conducted at SRI by Scientology OT VIIs Hal



Puthoff—who is Director of the SRI facility—and Ingo Swann. The Fort Meade unit is housed in two single-story wooden structures numbered 2560 and 2561. Fort Meade is a base for the National Security Agency (NSA) and part of the Army's Intelligence and Security Command (INSCOM), under which GRILL FLAME is officially established. GRILL FLAME takes its orders from the Pentagon's Office of the Army's Assistant Chief of Staff for Intelligence, and its tasking originates from CIA, DIA, and the President's National Security Council (NSC). Only a few dozen officials in the intelligence community have been briefed on the existence of GRILL FLAME. "Access is limited," an Army memorandum of the time notes, "to those personnel approved on a 'by name' basis."

- Joseph McMoneagle is a consultant for the SRI remote viewing labs OT VII Hal Puthoff is Director, and where OT VII Ingo Swann trains government remote viewers. McMoneagle is being assigned numerous remote viewing tasks, for which he will later be granted a Legion of Merit award for excellence in intelligence service. \*U.S. Intelligence agencies have become aware that the Russians have built the largest building under a single roof in the world. No one in the agencies, however, knows what is going on inside. The President's National Security Council staff orders INSCOM to have remote viewers see what they can determine about it. One of INSCOM's better remote-viewers, Joseph McMoneagle (a consultant with OT VII Hal Puthoff) reports, after his remote viewing of the facility, that a very large, new submarine with 18-20 missile launch tubes and a "large flat area" at the aft end will be launched in 100 days. Two Soviet subs, one with 24 launch tubes, and the other with 20 launch tubes and a large flat aft deck, are sighted 120 days later. These are new Soviet "Typhoon"-class submarines—the largest in the world.<sup>[111][112][113][94]</sup>

### Friday, 23 November 1979

- The Joint Chiefs of Staff issue orders for Scientology-trained government remote-viewing personnel to begin providing information on the location and condition of the Iranian hostages. *[NOTE: A total of 206 remote-viewing sessions are ultimately devoted to the Iranian hostage crisis.]*

## 1980s to Present

### Friday, 28 May 1982

- On the tenth anniversary of the purported Watergate first break-in, a corporation called Church of Spiritual Technology (CST), doing business as the "L. Ron Hubbard Library," is created that controls all of L. Ron Hubbard's intellectual property, including all research and materials of Scientology, including the OT Levels. Three non-Scientology lawyers create the corporation and appoint themselves for life as its "Special Directors," vesting in themselves ultimate control over the corporation and all of the intellectual properties. The corporation has been created as part of a Scientology "restructuring" engineered by a former Assistant to Commissioner of IRS, Meade Emory.

### Circa July 1982

- OT VII Ingo Swann, under the direction of OT VII Harold Puthoff, head of the Remote Viewing Laboratory at SRI, is training remote viewers for the the Army. According to Major Ed Dames, he and five others are sent to be trained by Swann, purportedly in a "new model" of remote viewing. *[NOTE: Ed Dames has been documented as lying publically about the involvement of Scientology and of OT VII's Hal Puthoff and Ingo Swann in the genesis of remote viewing, and reasonably is viewed as a primary source of CIA disinformation and phony technology"related to the subject. See CST and the CIA.]*

### Tuesday, 16 July 1984

- A press release promises construction in Los Angeles of an \$8 million "L. Ron Hubbard Library" where the original works of Hubbard "will be made readily accessible" to all. The release goes on to say that "until construction of the library," all the original manuscripts and tapes have been buried "in a series of underground vaults in half a dozen separate, but undisclosed locations." *[NOTE: No such library ever was built. The original works still remain buried in one or more underground vaults, of which only three have ever been identified. Also, the release omits any mention of the Meade Emory-created CST, which controls all the works, or of the fact that it is doing business at the time of the release under the exact name as the promised library (see 28 May 1982).]*<sup>[114][115]</sup>

**Monday, 24 August 1992**

- The Church of Spiritual Technology (CST), which had been set up by a former Assistant to the Commissioner of IRS, Meade Emory, to control all of L. Ron Hubbard's works, makes a land swap with the U.S. government, giving the federal government one of the vaults it has constructed—the Tremontina Base in New Mexico, and all the developments on it—in exchange for a like-sized but much cheaper piece of public and undeveloped land nearby. There is no accounting for the contents of the vault traded to the U.S. government. [NOTE: See Tremontina Base for full coverage.]

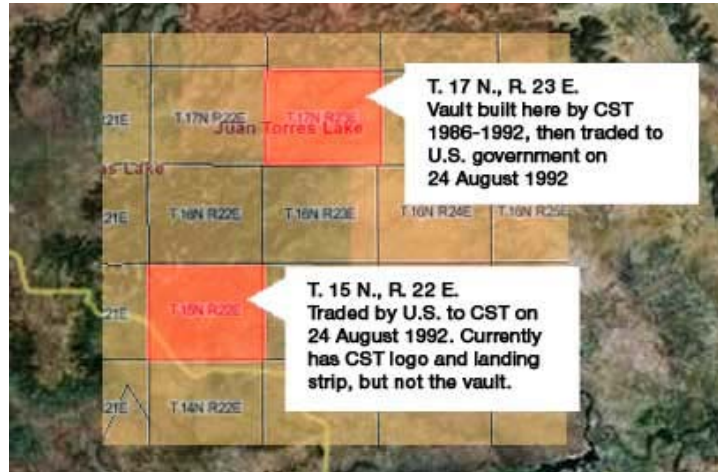

CST trades land with an underground vault to U.S. government at a major loss, including millions of dollars invested in building the vault. The land CST takes in trade is valued at only a little over \$28,000.

**Friday, 1 October 1993**

- Just over a year after the land swap (see 24 August 1992), the U.S. government restores tax exemption to Scientology. [NOTE: See 1967 for date of revocation.]

*The Church of Spiritual Technology"owns  
all of Hubbard's works, and has buried the originals  
in one or more underground vaults—then traded  
one of the vaults to the U.S. government, contents unknown.*

**Wednesday, 6 September 1995**

- Ordered to declassify certain information about remote viewing, the CIA has its public relations office issue the following: "As mandated by Congress, CIA is reviewing available information and past research programs concerning parapsychological phenomena, mainly 'Remote Viewing' to determine whether they might have any utility for intelligence collection. CIA sponsored research on this subject in the 1970s. At that time, the program, always considered speculative and controversial, was determined to be unpromising." <sup>[116]</sup>

**June 1998**

- Remote viewer Joe McMoneagle says in an interview about CIA's remote viewing programs: "Probably less than two percent of the information pertinent to the program has been released; certainly almost none of the operational data. A great deal of the research data is still classified as well." <sup>[117]</sup>

## Afterword

As is well and thoroughly covered elsewhere, the "Church of Spiritual Technology" (CST) created altered versions of all of Hubbard's books and materials and began systematically replacing the originals with the altered versions. Even Hubbard taped lectures were edited, sometimes with entire sections removed. Earlier versions of the Hubbard works were collected up and destroyed. The claim was that the new versions were "correcting" the earlier versions.

Around the same time that the Guardian Office was destroyed, copies of what were purported to be the confidential upper materials began to be published in several media sources, first in a small Las Vegas rag called the *Las Vegas Review-Journal*, later in some broader publication magazines, and even excerpts in the *Los*

*Angeles Times* and the *Washington Post*—whose Office of Naval Intelligence officer/reporter Bob Woodward told the world what it should be allowed to know about Watergate. No sources have ever been revealed for these purported confidential Scientology materials. Given the proven track of CST altering the works, and the fact that federal agencies had confidential upper-level Scientology materials in their files, there is sound foundation for the belief that the "OT Levels" in circulation are altered forgeries.

CST has made certain that it can never be proven one way or another by burying the original works in underground vaults, at least one of which they traded into the possession and control of the U.S. federal government on 24 August 1992.

## References

1. [^ a b c d e f g h i j k l m n o p q r s t u v w x y z aa ab ac ad ae af ag ah](#) Hunt, E. Howard *Undercover, Memoirs of an American Secret Agent* Berkely ISBN 399-11446-7
2. [^ a b c d e f g h i j](#) Wells, Tom *Wild Man; The Life and Times of Daniel Ellsberg*
3. [^ a b c d e](#) *What is Scientology?* Bridge Publications Los Angeles ISBN 1-573-18122-6
4. [^](#) Hubbard, L. Ron "The Story of Dianetics and Scientology" lecture of 18 October 1958
5. [^](#) "Key Events in CIA's History," *CIA Factbook on Intelligence* 2002
6. [^](#) Weiner, Tim "Robert Komer, 78, Figure in Vietnam, Dies" *The New York Times* 12 April 2000
7. [^](#) [Scan of letter](#)
8. [^ a b](#) Chase, Alston *Harvard and the Unabomber: The Education of an American Terrorist* W.W. Norton & Company 2003
9. [^ a b](#) Ross, Colin *Bluebird: Deliberate Creation of Multiple Personality by Psychiatrists*, Manitou Communications, 2000
10. [^](#) Hubbard, L. Ron *Dianetics, the Modern Science of Mental Health* 1950
11. [^ a b c d](#) *What is Scientology* "Complete List of Books and Materials"
12. [^](#) [Scan of Hubbard letter of resignation, 27 May 1950](#)
13. [^](#) Hubbard, L. Ron "How We Have Addressed the Problem of the Mind" taped lecture 4 July 1957
14. [^](#) Hubbard, L. Ron "Group Dianetics" *Dianetic Auditor's Bulletin* Vol. 1 No. 7, January 1951
15. [^](#) Hubbard, L. Ron *Science of Survival* limited manuscript edition Wichita, Kansas 25 June 1951
16. [^](#) [Project ARTICHOKE](#)
17. [^ a b c d e f g h i j k l m n](#) Ebon, Martin "[Amplified Mind Power Research In The Former Soviet Union](#)" Retrieved April 29, 2006
18. [^](#) Hubbard, L. Ron *What to Audit* Scientific Press, Phoenix, Arizona July 1952 and "History of Man" Hubbard Association of Scientologists, London, July 1952
19. [^ a b c d e f g h i j k l m n o p q r s t u v w x y z aa ab ac ad ae af ag ah ai aj](#) Kress, Dr. Kenneth A. "Parapsychology in Intelligence: A Personal Review and Conclusions" *Studies in Intelligence* (CIA publication) Winter 1977
20. [^ a b](#) Schwalbe, David "LSD and the CIA, Part 2" *Dateline* 14 March 1999
21. [^](#) Hubbard, L. Ron *Philadelphia Doctorate Course* lecture series
22. [^ a b c d e f g](#) Kutler, Stanley I. *Abuse of Power: the New Nixon Tapes*
23. [^ a b](#) Lee, Martin A. and Shlain, Bruce *Acid Dreams; The CIA, LSD and the Sixties Rebellion* Grove Press, New York: 1985; ISBN 0-394-55013-7
24. [^](#) [MK-ULTRA](#)
25. [^ a b c d](#) Martin, Harry V. and Caul, David "Mind Control" *Napa Sentinel* August-November 1991 <http://www.whale.to/b/caul.html>
26. [^ a b c](#) Hubbard, L. Ron "Politics, Freedom From" LRH Secretarial Executive Directive 56 Int 14 June 1965 reissued as Hubbard Communication Office Policy Letter 10 January 1968
27. [^](#) *Declassified Documents—Microfilms Under MKULTRA* Research Publications Woodbridge, CT 1984 002258

28. [^ a b c d e](#) *Church of Scientology vs. Commissioner of Internal Revenue* Docket No. 3352-78 United States Tax Court filed 24 September 1984
29. [^](#) Miller, Russell *Bare Faced Messiah*
30. [^ a b c d e f g h i j k l](#) Ellsberg, Daniel *Secrets: A Memoir of Vietnam and the Pentagon Papers* Penguin 2003 ISBN 0-142-00342-5
31. [^](#) "Plants Do Worry and Feel Pain," *Garden News* 18 December 1959
32. [^](#) Hubbard, L. Ron "Creation and Goals" a recorded lecture of 3 August 1961
33. [^](#) Sea Org Orders of the Day (OODs) 28 February 1969
34. [^ a b c d e](#) Judiciary Committee Impeachment hearings, Testimony of Witnesses, Book III: Responses by CIA to questions submitted by the Committee
35. [^](#) Cooper, Paulette *The Scandal of Scientology*
36. [^](#) Hubbard, L. Ron "Level VII" a taped lecture of 23 February 1965
37. [^](#) Hubbard, L. Ron "The Well-Rounded Auditor" a taped lecture of 29 June 1965
38. [^ a b c d e f g h](#) A.J. Weberman
39. [^](#) Hubbard, L. Ron, Scientology Policy of 28 December 1965, revised 1968, "Enrollment in Suppressive Groups"
40. [^](#) Hubbard, L. Ron, Scientology Policy of 6 December 1976, revised 8 April 1988, "Illegal PCs, Acceptance Of"
41. [^](#) Burton, Christine "Green Music" article
42. [^](#) Hubbard, L. Ron "Clearing Course Security" Scientology policy letter of 16 August 1966
43. [^](#) Hubbard, L. Ron "OT Personnel" Scientology policy letter 10 November 1966 Issue II
44. [^ a b c d e f g h i j k l m n o p q r s t u v w x y z aa ab ac ad ae af ag ah ai aj ak al am an ao ap aq](#) Swann, Ingo *Remote Viewing—The Real Story*
45. [^](#) Miller, Russel Interview with David Mayo
46. [^ a b](#) Miller, Russell *Bare Faced Messiah*
47. [^](#) Meade Emory profile
48. [^](#) Tanner, Jerald "Mormon Spies, Hughes and the CIA" citing testimony before Judiciary Committee Impeachment hearings, Book III
49. [^](#) CIA memo #104-10119-10323 from CIA Chief Central Cover Staff Corporate Cover Branch
50. [^](#) James McCord biography
51. [^ a b c d e f g h i j k l m n](#) Liddy, G. Gordon *Will, the Autobiography of G. Gordon Liddy* St. Martin's ISBN 0-312-92412-7
52. [^](#) Hal, Puthoff "Success Story" Scientology Advanced Org Los Angeles (AOLA) special publication, blue painting cover, printed in 1971
53. [^ a b c d e f g](#) Liddy, G. Gordon Deposition in *Dean v. Liddy et al.*, U.S. District Court D.C. 92-1807
54. [^](#) Smith, J. "List of CIA Agents" *Intelligence/Parapolitics* magazine Brussels November 1985
55. [^](#) Miller, Russell Interview with Kima Douglas
56. [^](#) "Data Concerning the Death of Scientology Parishioner Susan Meister" Company Memorandum TSMY *Apollo*
57. [^](#) White House Plumbers
58. [^](#) Campaign Contributions Task Force #804—Hughes/Rebozo Investigation, Box 86, Caulfield, John: "7/71 Sandwedge proposal"
59. [^](#) Caulfield, John J. (Jack Caulfield) "In Their Own Words"
60. [^ a b c d](#) Memorandum for the Record: "Summary of Mr. Karl Wagner's Knowledge of CIA Assistance to Mr. E. Howard Hunt" Judiciary Committee Impeachment hearings
61. [^ a b c d](#) Memorandum for the Record: "Summary of Contacts by Mr. Stephen Carter Greenwood with Mr. E. Howard Hunt" Judiciary Committee Impeachment hearings Book III
62. [^ a b c](#) "Orders of the Day" (OODs) of the Scientology Flagship *Apollo* 1971-1972
63. [^](#) Hubbard, L. Ron "Advanced Courses" Scientology policy letter of 12 August 1971
64. [^ a b](#) Transcript of recording of a meeting among the President, John Dean, and H.R. Haldeman in the Oval Office on March 17, 1973 from 1:25 pm to 2:10 pm
65. [^ a b c](#) Bernard Barker testimony, May 11 and May 24, 1973 Judiciary Committee Impeachment Hearings Book I, Events Prior to the Watergate Break-in

66. [^](#) [Victorian](#), Armen, quoting Ingo Swann "Remote Viewing and the U.S. Intelligence Community" *Lobster* Issue 31: June 1996
67. [^](#) [a](#) [b](#) [Brussell](#), Mae "[Why Was Martha Mitchell Kidnapped](#)" *The Realist* August 1972
68. [^](#) [House of Representatives Judiciary Committee Impeachment Hearings](#), Book I
69. [^](#) "[Chasing George W. Bush and the F-102](#)"
70. [^](#) [Citrine](#), Charlie [Watergate Timeline](#)
71. [^](#) [a](#) [b](#) [c](#) [LaMother](#), Captain John D. Defense Intelligence Agency (DIA) Report: "Controlled Offensive Behavior—USSR" DIA Task Number T72-01-14 [Controlled Offensive Behavior—USSR](#) large PDF file
72. [^](#) [Caddy](#), Douglas "Gay Bashing and Watergate" *Advocate.com* 1 August 2005
73. [^](#) [a](#) [b](#) [c](#) [FBI files on L. Ron Hubbard](#)
74. [^](#) [United States Court of Appeals](#), Eighth Circuit ruling April 10, 1972 [Church of Scientology of Minnesota et al. v. Department of Health, Education & Welfare, etc., et al. No. 71-1507](#)
75. [^](#) [a](#) [b](#) [c](#) "[Bug Suspects Got Campaign Funds](#)" *Washington Post*
76. [^](#) [FBI report dated 22 June 1972](#), "Memorandum to Mr. Bolz"
77. [^](#) [a](#) [b](#) [c](#) [d](#) [e](#) [f](#) [g](#) [Congressional testimony of Alfred Baldwin](#), 24 May 1973
78. [^](#) [Document in PDF format "BushGuardmay4.pdf"](#) released by CBS news in September 2004
79. [^](#) [a](#) [b](#) [c](#) [d](#) [e](#) [U.S. v. George Gordon Liddy et al. Grand Jury Indictment; Grand Jury sworn in on June 5, 1972](#)
80. [^](#) [James McCord testimony](#), May 11 and May 24, 1973 [Judiciary Committee Impeachment Hearings Book I, Events Prior to the Watergate Break-in](#)
81. [^](#) [Document in PDF format "BushGuardmay19.pdf"](#) released by CBS news in September 2004
82. [^](#) [Excerpt of letter from Nixon to Kissenger and Haig](#)
83. [^](#) [a](#) [b](#) [c](#) [The Public Papers of President Richard Nixon; 1972](#)
84. [^](#) [U.S. vs. G. Gordon Liddy](#), appelant No. 73-1565 [United States Court of Appeals District of Columbia](#), decided 8 November 1974
85. [^](#) [Watergate first break-in](#)
86. [^](#) [Arlington National Cemetary web page on John Paul Vann](#)
87. [^](#) [Helms](#), Richard and Hood, William *A Look Over My Shoulder* Random House, 2003
88. [^](#) [a](#) [b](#) [c](#) [d](#) [e](#) [f](#) [Testimony of L. Patrick Gray](#), former Acting Director of the Federal Bureau of Investigation, in [Congressional hearings](#), 3 and 6 August 1973
89. [^](#) [Transcript from web site "History and Politics Out Loud"](#)
90. [^](#) [Church of Scientology v. IRS](#), No. 3352-78, [United States Tax Court](#), filed 24 September 1978
91. [^](#) [a](#) [b](#) [Watergate Chronology](#)
92. [^](#) ["Watergate burglars indicted"](#) [NBC News abstract](#)
93. [^](#) [a](#) [b](#) [c](#) [d](#) [e](#) [House of Representatives Judiciary Committee Impeachment Hearings](#), Book III
94. [^](#) [a](#) [b](#) [c](#) [d](#) [e](#) [f](#) [g](#) [h](#) [i](#) [j](#) [k](#) [l](#) [m](#) [n](#) [o](#) [p](#) [q](#) [r](#) [s](#) [t](#) [u](#) [v](#) [w](#) [x](#) [Schnabel](#), Jim *Remote Viewers: The Secret History of America's Psychic Spies* Dell (1997) ISBN 0-440-22306-7
95. [^](#) [Bio of Jack Caulfield](#)
96. [^](#) ["Project MKULTRA, the CIA's Program of Research in Behavioral Modification"](#) Report by U.S. Senate Select Committee on Intelligence
97. [^](#) [The New York Times Company Timeline: NY Times Timeline 1971-2000](#)
98. [^](#) [a](#) [b](#) [c](#) [d](#) [e](#) [f](#) [g](#) [h](#) [Powers](#), Thomas "Inside the Department of Dirty Tricks" *Atlantic Monthly* August 1979 Volume 244 No. 2 pages 33-64
99. [^](#) ["Pentagon Papers: Case Dismissed"](#) *Time* magazine 21 May 1973
100. [^](#) ["Break-In Memo Sent to Ehrlichman"](#) [Washington Post Staff Writers](#) Wednesday, June 13, 1973
101. [^](#) [Jensen](#), Derrick "The Plants Respond: An Interview with Cleve Backster" *The Sun* July 1997
102. [^](#) [Celebrity magazine Minor Issue](#) 8 November 1973
103. [^](#) [RTC v. FACTnet, Inc.](#) US District Court Colorado No. 95B2143 [testimony of Robert Vaughn Young](#) 21 September 1995
104. [^](#) [Celebrity magazine Minor Issue](#) 11 September 1974
105. [^](#) [Celebrity magazine Major Issue](#) 21
106. [^](#) [O'Leary](#), J. "Turner Denies CIA Bugging of South Korea's Park" *The Washington Star* 9 August 1977.
107. [^](#) [Swann](#), Ingo *The 1973 Remote Viewing Probe of the Planet Jupiter*

108. [^](#) [Puthoff, Hal "CIA-Initiated RV Program at SRI" article](#)
109. [^](#) [Puthoff, Harold and Targ, Russell, "Direct Perception of Remote Geographical Locations", SRI Menlo Park, 1979](#)
110. [^](#) [Targ, Russell \*Miracles of Mind; Remote Viewing\*](#)
111. [^](#) [May, Dr. Edwin C. "Response to the CIA/AIR Report on Remote Viewing"](#)
112. [^](#) ["Interview with Joseph McMoneagle" \*Psychic World\* Summer issue 1998](#)
113. [^](#) [STAR GATE \(Controlled Remote Viewing\)](#)
114. [^](#) [Untitled PR Newswire press release dated July 17 1984 but with July 16 dateline, begins "Construction of an \\$8 million library..."](#)
115. [^](#) [Untitled PR Newswire press release dated July 17 1984 with July 17 dateline, begins "Construction of an \\$8 million library..." \(text different from similar release with 16 July 1984 dateline\)](#)
116. [^](#) [CIA Public Affairs Office "CIA Statement on 'Remote Viewing'", 6 September 1995](#)
117. [^](#) [Csere, Tom "Interview with Joe McMoneagle, World-Class Remote Viewer" \*Psychic World\* Summer 1998](#)
118. [^](#) [Colodny, Len and Gettlin, Robert \*Silent Coup: The Removal of a President\*](#)

For more in-depth information on events in this timeline, visit the [Timeline Project at Hearthside Forums](#)